

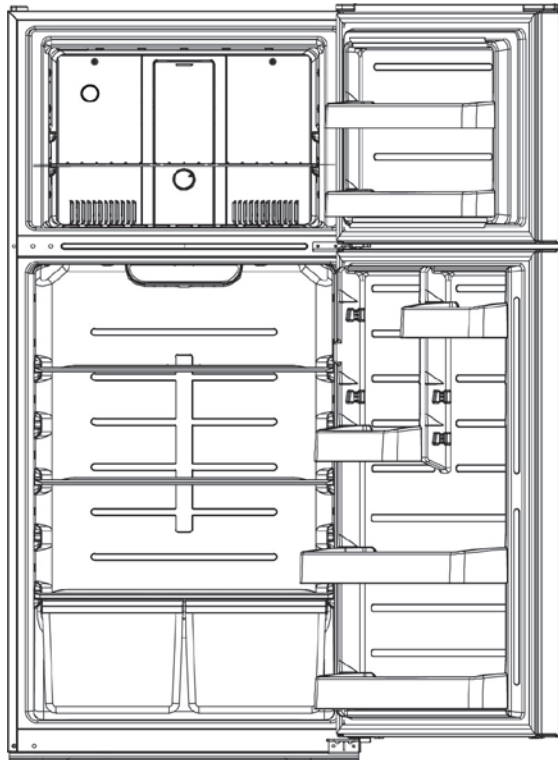

**INSTRUCTION MANUAL
MANUAL DE INSTRUCCIONES**

Model Numbers / No. de Modelos : FF18D0W / FF18D1B / FF18D3S

**DELUXE FROST FREE REFRIGERATOR-FREEZER
REFRIGERADOR-CONGELADOR**



BEFORE USE, PLEASE READ AND FOLLOW ALL SAFETY RULES AND OPERATING INSTRUCTIONS.

La sección en español empieza en la página 17.

Avanti has a policy of continuous improvement on its products and reserves the right to change materials and specifications without notice.

Avanti Products LLC
P.O. Box 520604 - Miami, Florida 33152
www.avantiproducts.com

TABLE OF CONTENTS

Refrigerator Safety	4
Important Safeguides	5
Help Us Help You	6
Parts and Features	7
Installing the Door Handles	7
Important Safety Instructions	8
Installation Instructions	8
Before Using Your Appliance	8
Installation of Your Appliance	8
Electrical Connection	9
Operating Your Appliance	10 - 11
Freezing Fresh Foods	11
Care and Maintenance	12
Ice Maker Installation	12
Reversing the Door Swing of Your Appliance	12
Cleaning Your Appliance	12
Power Failure / Vacation Time, Moving Your Appliance	12
Energy Saving Tips	12
Changing the Light Bulb	13
Troubleshooting Guide	14
Service for Your Appliance	15
Your Avanti Products Warranty	16
Instrucciones en Español	17 - 20
Registration Information and Registration Card	Last Page

REFRIGERATOR SAFETY

Your safety and the safety of others are very important.

We have provided many important safety messages in this manual for your appliance. Always read and obey all safety messages.



This is the Safety Alert Symbol. This symbol alerts you to potential hazards that can kill or injure you and others. All safety messages will follow the Safety Alert Symbol and either the words "DANGER", "WARNING" or "CAUTION".



Danger means that failure to heed this safety statement may result in severe personal injury or death.



Warning means that failure to heed this safety statement may result in extensive product damage, serious personal injury, or death.



Caution means that failure to heed this safety statement may result in minor or moderate personal injury, property or equipment damage.

All safety messages will alert you to know what potential hazard is, tell you how to reduce the chance of injury, and let you know what can happen if the instructions are not followed.

IMPORTANT SAFEGUIDES



Before the refrigerator is used, it must be properly positioned and installed as described in this manual, so read the manual carefully. To reduce the risk of fire, electrical shock or injury when using the refrigerator, follow basic precautions, including the following:

DANGER

- Plug into a grounded 3-prong outlet, do not remove grounding prong, do not use an adapter, and do not use an extension cord.
- It is recommended that a separate circuit, serving only your refrigerator be provided. Use receptacles that cannot be turned off by a switch or pull chain.
- Never clean refrigerator parts with flammable fluids. These fumes can create a fire hazard or explosion. And do not store or use gasoline or other flammable vapors and liquids in the vicinity of this or any other appliance. The fumes can create a fire hazard or explosion.
- Before proceeding with cleaning and maintenance operations, make sure the power line of the unit is disconnected.
- Do not connect or disconnect the electric plug when your hands are wet.
- Unplug the refrigerator or disconnect power before cleaning or servicing. Failure to do so can result in electrical shock or death.
- Do not attempt to repair or replace any part of your refrigerator unless it is specifically recommended in this manual. All other servicing should be referred to a qualified technician.

WARNING

FOLLOW WARNING CALL OUTS BELOW ONLY WHEN APPLICABLE TO YOUR MODEL

- Use two or more people to move and install refrigerator. Failure to do so can result in back or other injury.
- To ensure proper ventilation for your refrigerator, the front of the unit must be completely unobstructed. Choose a well-ventilated area with temperatures above 60°F (16°C) and below 90°F (32°C). This unit must be installed in an area protected from the element, such as wind, rain, water spray or drips.
- The refrigerator should not be located next to ovens, grills or other sources of high heat.
- The refrigerator must be installed with all electrical, water and drain connections in accordance with state and local codes. A standard electrical supply (115 V AC only, 60 Hz), properly grounded in accordance with the National Electrical Code and local codes and ordinances is required.
- Do not kink or pinch the power supply cord of refrigerator.
- The fuse (or circuit breaker) size should be 15 amperes.
- It is important for the refrigerator to be leveled in order to work properly. You may need to make several adjustments to level it.
- All installation must be in accordance with local plumbing code requirements.
- Make certain that the pipes are not pinched or kinked or damaged during installation.
- Check for leaks after connection.
- Never allow children to operate, play with or crawl inside the refrigerator.
- If you use the drainage container, you must unplug the unit or the water can overflow from the drainage container
- Although the unit has been tested at the factory, due to long-term transit and storage, the first batch of ice cubes must be discarded.
- Do not use solvent-based cleaning agents or abrasives on the interior. These cleaners may damage or discolor the interior.
- Do not use this apparatus for anything other than its intended purpose.

HELP US HELP YOU...

Read this guide carefully.

It is intended to help you operate and maintain your new refrigerator-freezer properly.

Keep it handy to answer your questions. If you don't understand something or you need more assistance, please call:

**Avanti Customer Service
800-220-5570**

Keep proof of original purchase date (such as your sales slip) with this guide to establish the warranty period.

CAUTION:

THIS REFRIGERATOR-FREEZER IS NOT DESIGNED FOR THE STORAGE OF MEDICINE OR OTHER MEDICAL PRODUCTS.

Write down the model and serial numbers.

You'll find them on a plate located on the rear wall of the refrigerator-freezer.

Please write these numbers here:

Date of Purchase

Model Number

Serial Number

Use these numbers in any correspondence or service calls concerning your refrigerator-freezer.

If you received a damaged refrigerator-freezer, immediately contact the dealer (or builder) that sold you the refrigerator-freezer.

Save time and money. Before you call for service, check the Troubleshooting Guide. It lists causes of minor operating problems that you can correct yourself.

IF YOU NEED SERVICE

We're proud of our service and want you to be pleased. If for some reason you are not happy with the service you receive, here are some steps to follow for further assistance.

FIRST, contact the people who serviced your refrigerator-freezer. Explain why you are not satisfied. In most cases, this will solve the problem.

NEXT, if you are still not pleased, write all the details, including your telephone number, and send it to:

**Customer Service
Avanti Products
10880 NW 30 Street
Miami, FL 33172**

PARTS AND FEATURES

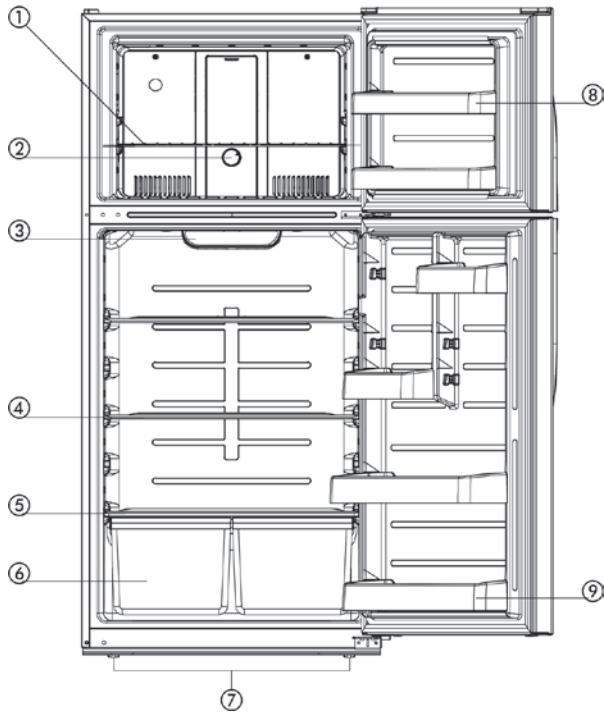

1	Freezer Shelf
2	Freezer Temperature Control
3	Refrigerator Temperature Control
4	Refrigerator Shelves (2)
5	Crisper Cover
6	Vegetable Crispers (2)
7	Leveling Legs (2)
8	Freezer Door with Storage Bins (2)
9	Refrigerator Door with Storage Bins (4)

DOOR HANDLE INSTALLATION

NOTE: FIGURES IN THE USER MANUAL ARE ONLY FOR REFERENCE. THE ACTUAL PRODUCT MAY DIFFER SLIGHTLY.

The refrigerator must be disconnected from the electrical supply before attempting the installation of any accessory.

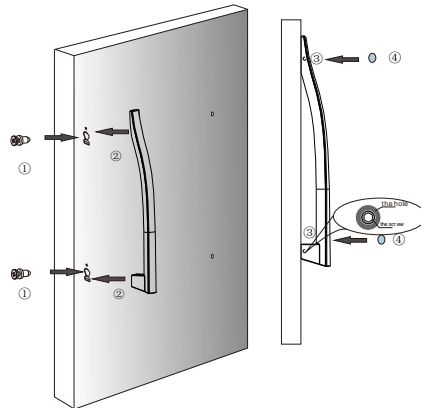

(Photos may vary from actual unit)

- ① Remove the Allen head screw from the accessory bag; install them into the door holes; secure to the door until they are tight but do not overtighten.
- ② Align the handles with the screws installed in step #1
- ③ Insert the screws through the holes at the sides of the handles, and tighten until secure. Do not overtighten.
- ④ Place the screw hole cover in the hole to complete the installation.

IMPORTANT SAFETY INSTRUCTIONS

⚡WARNING⚡	To reduce the risk of fire, electrical shock, or injury when using your refrigerator-freezer, follow these basic precautions:
<ul style="list-style-type: none">• Read all instructions before using the refrigerator-freezer.• DANGER or WARNING: Risk of child entrapment. Child entrapment and suffocation are not problems of the past. Junked or abandoned refrigerator-freezers are still dangerous. . . even if they will “just sit in the garage a few days.”• Before you throw away your old refrigerator-freezer: Take off the doors. Leave the shelves in place so that children may not easily climb inside.• Never allow children to operate, play with, or crawl inside the refrigerator-freezer.• Never clean refrigerator-freezer parts with flammable fluids. The fumes can create a fire hazard or explosion.• Do not store or use gasoline or any other flammable vapors and liquids in the vicinity of this or any other refrigerator-freezer. The fumes can create a fire hazard or explosion.	
-Save these instructions-	

INSTALLATION INSTRUCTIONS

➤ Before Using Your Appliance

- Remove the exterior and interior packing.
- Check to be sure you have all of the following parts:
 - 2 Refrigerator Shelves
 - 2 Vegetable Crispers
 - 1 Glass Crisper Cover
 - 2 Freezer Bins
 - 1 Instruction Manual
 - 1 piece of door stopper for the reversal of door opening
 - 2 pieces of hole cover for middle hinge
 - 1 Allen Wrench
- Before connecting the unit to the power source, let it stand upright for approximately 2 hours. This will reduce the possibility of a malfunction in the cooling system from handling during transportation.
- Clean the interior surface with lukewarm water using a soft cloth.

➤ Installation of Your Appliance

- Place your refrigerator-freezer on a floor that is strong enough to support the refrigerator-freezer when it is fully loaded. To level your refrigerator-freezer, adjust the leveling legs at the bottom of unit.
- Allow 5 inches of space between the back and sides of the unit, which allows the proper air circulation to cool the compressor and condenser.
- Locate the unit away from direct sunlight and sources of heat (stove, heater, radiator, etc.). Direct sunlight may affect the acrylic coating and heat sources may increase electrical consumption. Extreme cold ambient temperatures may also cause the refrigerator-freezer not to perform properly.
- Avoid locating the unit in moist areas.
- Plug the unit into an exclusive properly installed-grounded wall outlet. Do not under any circumstances cut or remove the third (ground) prong from the power cord. Any questions concerning power and/or grounding should be directed toward a certified electrician or an authorized Avanti Products service center.

➤ **ELECTRICAL CONNECTION**

⚡ Warning ⚡

Improper use of the grounded plug can result in the risk of electrical shock. If the power cord is damaged, have it replaced by an authorized Avanti Products service center.

This appliance should be properly grounded for your safety. The power cord of this appliance is equipped with a three-prong plug which mates with standard three prong wall outlets to minimize the possibility of electrical shock.

Do not under any circumstances cut or remove the third ground prong from the power cord supplied. For personal safety, this appliance must be properly grounded.

This appliance requires a standard 115/120 Volt AC ~/60Hz electrical ground outlet with three-prong. Have the wall outlet and circuit checked by a qualified electrician to make sure the outlet is properly grounded. When a standard 2-prong wall outlet is encountered, it is your responsibility and obligation to have it replaced with a properly grounded 3-prong wall outlet.

The cord should be secured behind the appliance and not left exposed or dangling to prevent accidental injury.

The appliance should always be plugged into its own individual electrical outlet which has a voltage rating that matches the rating label on the appliance. This provides the best performance and also prevent overloading house wiring circuits that could cause a fire hazard from overheated. Never unplug the appliance by pulling the power cord. Always grip the plug firmly and pull straight out from the receptacle. Repair or replace immediately all power cords that have become frayed or otherwise damaged. Do not use a cord that shows cracks or abrasion damage along its length or at either end. When moving the appliance, be careful not to damage the power cord.

➤ **EXTENSION CORD**

Because of potential safety hazards under certain conditions, it is strongly recommended that you do not use an extension cord with this appliance. However, if you must use an extension cord it is absolutely necessary that it be a UL/CUL-Listed, 3-wire grounding type appliance extension cord having a grounding type plug and outlet and that the electrical rating of the cord be 115 volts and at least 10 amperes.

➤ **SURGE PROTECTOR**

Most electrical appliances use a series of electric control boards to operate. These boards are very susceptible to power surges and could be damaged or destroyed.

If the appliance is going to be used in an area or if your city / country is prone to power surges / outages; it is suggested that you use a power surge protector for all electrical devices / appliances you use. The surge protector that you select must have a surge block high enough to protect the appliance it is connected to. If you have any questions regarding the type and size of surge protector needed contact a licensed electrician in your area.

Damages due to power surges are not considered a manufacturer covered defect and will void your product warranty.

OPERATING YOUR APPLIANCE

➤ Temperature Control Panels

Refrigerator Temperature Control

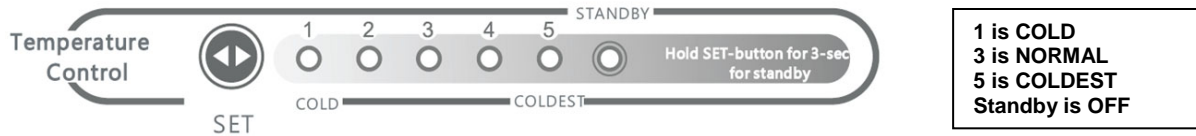

Standby is OFF, this will turn off all cooling functions but not the power to the unit.

Freezer Control

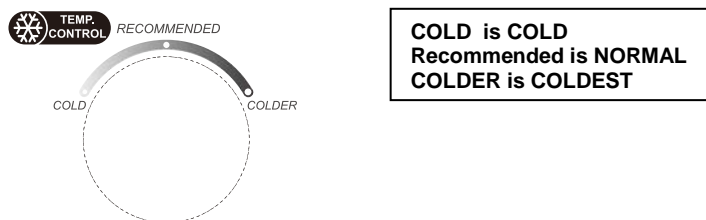

➤ Setting the Temperature Control

- Your refrigerator has one control for regulating the temperature. The temperature control is located on the top of the refrigerator compartment. As well as a control knob in the freezer to balance the cold air distribution between the two compartments.
- The temperature control in the refrigerator compartment will control the actual cooling cycle whereas the control knob in the freezer compartment will adjust the distribution of the cold air between the freezer and the refrigerator compartments.
- The first time you turn the unit on, adjust the temperature control knob to “MAX” in the freezer compartment and “5” in the refrigerator compartment and run for at least 4 hours before placing foods inside. This will ensure the freezer cabinet is thoroughly chilled and the refrigerator compartment will be stabilized before food is placed. Then return selector to “**Recommended**” position in the freezer compartment and “3” in the refrigerator compartment.
- Adjust the temperature control to the setting that best suits your needs. The setting of “3” in the refrigerator compartment and “**Recommended**” in the freezer compartment will distribute the cold air equally between both compartments which should be appropriate for home or office refrigerator use.
- If you at any time want to distribute a larger amount of cold air to the freezer for example is a large amount of food has been added to the freezer, simply move the controller to the “MAX” position until the desired temperature has been attained then return the controller to the “**Recommended**” position.
- If you at any time want to distribute a larger amount of cold air to the refrigerator section, for example to quickly cook down if a large amount of fresh food has been added, simply move the controller in the freezer to the “MIN” position until the desired temperature has been attained and then return the controller to the “**Recommended**” position.

NOTE:

- IF THE UNIT IS UNPLUGGED, HAS LOST POWER, OR IS TURNED OFF, YOU MUST WAIT 3 TO 5 MINUTES BEFORE RESTARTING THE UNIT. IF YOU ATTEMPT TO RESTART BEFORE THIS TIME DELAY, THE REFRIGERATOR-FREEZER WILL NOT START.

NOTE:

WE DO NOT RECOMMEND THE INSTALLATION OF THE REFRIGERATOR WHERE THE TEMPERATURE WILL DROP BELOW 50°F (13°C) OR RISE ABOVE 110°F (43°C). THE COMPRESSOR WILL NOT BE ABLE TO MAINTAIN PROPER TEMPERATURES INSIDE THE REFRIGERATOR.

FOR INSTALLATIONS WHERE THE TEMPERATURES WILL DROP BELOW 50° SET THE FREEZER TEMPERATURE CONTROL TO THE “COLDEST” SETTING. THIS WILL IMPROVE THE OPERATIONS OF THE REFRIGERATOR UNDER THESE CONDITIONS.

➤ **Freezing Fresh Foods**

- Proper use of the appliance, adequately packed food, correct temperature and taking into account hygienic precautions will substantially influence the quality of freezing the food or storing of the frozen foods.
- This compartment is designed for the long-term storage of frozen food.
- The storage life of frozen foods varies and the recommended storage time should not be exceeded.
- Pre-packed commercially frozen food should be stored in accordance with the frozen foods manufacturer's instructions for a three star frozen food storage compartment or home freezer.
- Place frozen food into the freezer as quickly as possible after purchase. If there are instructions on the packet, carefully follow these instructions regarding storage times.
- Carefully select food you intend to freeze, it should be of adequate quality and suitable for freezing.
- Use correct packaging and wrap it tight.
- The packaging should be airtight and shouldn't leak since this could cause substantial vitamin loss and dehydration of foods.
- Foils and bags should be soft enough to tightly wrap around the foods.
- When preparing foods to be frozen, consider sanitary precautions.
- Mark packages with following data: kind and amount of foods and the date of loading.
- It is extremely important that the food is frozen as quickly as possible.
- If the loading amount is too large, the quality of freezing is reduced which affects the quality of frozen foods.

CARE AND MAINTENANCE

➤ **Ice Maker Installation**

This refrigerator-freezer has the capability of using an automatic ice-maker. The automatic ice-maker is optional and sold separately. Should you desire to install an automatic ice-maker, please call service for installation instructions.

➤ **Reversing the Door Swing of Your Appliance**

This refrigerator-freezer has the capability of the door opening from either the left or right side. The unit is delivered to you with the door opening from the left side. Should you desire to reverse the opening direction, please call service for reversal instructions.

➤ **Cleaning Your Appliance**

- Unplug the unit, and remove the food and baskets.
- Wash the inside with a warm water and baking soda solution. The solution should be about 2 tablespoons of baking soda to a quart of water.
- Wash the baskets with a mild detergent solution.
- The outside of the unit should be cleaned with mild detergent and warm water.

CAUTION

Failure to unplug the refrigerator-freezer could result in electrical shock or personal injury.

➤ **Power Failure**

Most power failures are corrected within a few hours and should not affect the temperature of your refrigerator-freezer if you minimize the number of times the door is opened. If the power is going to be off for a longer period of time, you need to take the proper steps to protect your food.

➤ **Vacation Time**

Short vacations: Leave the unit operating during vacations of less than three weeks.

Long vacations: If the appliance will not be used for several months, remove all food and unplug the power cord. Clean and dry the interior thoroughly. To prevent odor and mold growth, leave the door open slightly: blocking it open if necessary

➤ **Moving Your Appliance**

- Remove all the food.
- Securely tape down all loose items inside your unit.
- Turn the leveling screws up to the base to avoid damage.
- Tape the door shut.
- Be sure the unit stays in the upright position during transportation.

➤ **Energy Saving Tips**

- The unit should be located in the coolest area of the room, away from heat producing appliances or heating ducts, and out of direct sunlight.
- Let hot foods cool to room temperature before placing them in the unit. Overloading the unit forces the compressor to run longer. Foods that freeze too slowly may lose quality, or spoil.
- Be sure to wrap foods properly, and wipe containers dry before placing them in the unit. This cuts down on frost build-up inside the freezer.
- Organize and label food to reduce door openings and extended searches. Remove as many items as needed at one time, and close the door as soon as possible.

➤ **Replacing Your Light Bulb**

NOTE:

All parts removed must be saved to do the replacement of the light bulb.

Before removing the light bulb, either turn off the appliance or disconnect the electricity leading into the appliance at the main power supply. Failure to do so could result in electrical shock or personal injury.

- Unplug the AC power cord from the wall.
- Pull down to remove the lamp cover.
- Unscrew the bulb.
- Replace with a 15-watt bulb that is the same shape and size.

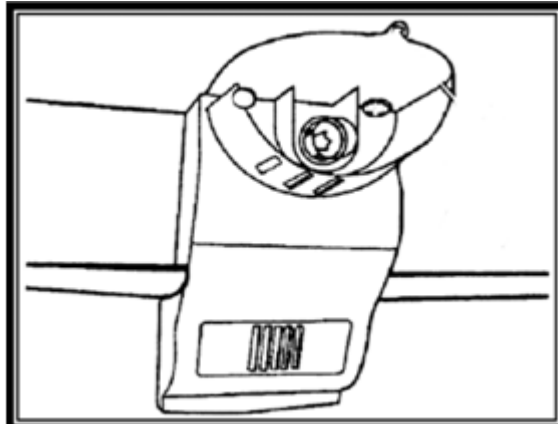

PROBLEMS WITH YOUR APPLIANCE?

You can solve many common refrigerator-freezer problems easily, saving you the cost of a possible service call. Try the suggestions below to see if you can solve the problem before calling for service.

TROUBLESHOOTING GUIDE

PROBLEM	POSSIBLE CAUSE
Unit does not operate.	Not plugged in. The circuit breaker tripped or there is a blown fuse.
Compressor turns on and off frequently.	The room temperature is hotter than normal. A large amount of food has been added to the refrigerator - freezer. The door is opened too often. The door is not closed completely. The temperature control is not set correctly. The door gasket does not seal properly. The refrigerator -freezer does not have the correct clearances.
Vibrations.	Check to assure that the refrigerator - freezer is level.
The unit seems to make too much noise.	The rattling noise may come from the flow of the refrigerant, which is normal. As each cycle ends, you may hear gurgling sounds caused by the flow of refrigerant in your refrigerator - freezer. Contraction and expansion of the inside walls may cause popping and crackling noises. The unit is not level.
The door will not close properly.	The unit is not level. The door is reversed and not properly installed. The gasket is dirty. The baskets are out of position.

SERVICE FOR YOUR APPLIANCE

We are proud of our customer service organization and the network of professional service technicians that provide service on your Avanti refrigerator - freezer. With the purchase of your Avanti refrigerator - freezer, you can be confident that if you ever need additional information or assistance, the Avanti Products Customer Service team will be here for you. Just call us toll-free.

AVANTI PRODUCTS CUSTOMER SERVICES

Product Information 800-323-5029	Whatever your questions are about our products, help is available.
Part Orders 800-220-5570	You may order parts and accessories that will be delivered directly to your home using personal check, money order, Master Card, or Visa.
In-Home Repair Service 800-220-5570	An Avanti Products authorized service center will provide expert repair service, scheduled at a time that is convenient for you. Our trained servicers know your refrigerator-freezer inside and out.

YOUR AVANTI PRODUCTS WARRANTY	Staple your sales receipt here. Proof of original purchase date is needed to obtain service under warranty.
<u>WHAT IS COVERED – LIMITED ONE-YEAR WARRANTY</u>	
Avanti Products warrants that the product is free from defects in materials and/or workmanship for a period of twelve (12) months from the date of purchase by the original owner. The foregoing timeline begins to run upon the date of purchase, and shall not be stalled, tolled, extended, or suspended for any reason whatsoever unless described in detail in the warranty document. For one year from the date of purchase by the original owner, Avanti products will, at its option, repair or replace any part of the product which proves to be defective in material or workmanship under normal use. Avanti Products will provide you with a reasonably similar product that is either new or factory refurbished. During this period Avanti Products will provide all parts and labor necessary to correct such defects free of charge, so long as the product has been installed and operated in accordance with the written instructions in this manual. In rental or commercial use, the warranty period is 90 days. All Avanti appliances of 4.2 cubic feet capacity or less must be brought/sent to the appliance service center for repair.	
<u>LIMITED SECOND THROUGH FIFTH YEAR WARRANTY</u>	
For the second through the fifth year from the date of original purchase, Avanti Products will provide a replacement compressor free of charge due to a failure. You are responsible for the service labor and freight charges. In rental or commercial use, the limited compressor warranty is one year and nine months. Costs involved to move the product to the service center and back to the user's home, as maybe required, are the user's responsibility.	
<u>WARRANTY EXCLUSIONS / WHAT IS NOT COVERED:</u>	
The warranty coverage described herein excludes all defects or damage that are not the direct fault of Avanti Products, including without limitation, one or more of the following:	
<ul style="list-style-type: none"> ● A failure to comply with any applicable state, local, city, or county electrical, plumbing and/or building codes, regulations, or laws, including failure to install the product in strict conformity with local fire and building codes and regulations. ● Any external, elemental and/or environmental forces and factors, including without limitation, rain, wind, sand, floods, fires, mud slides, freezing temperatures, excessive moisture or extended exposure to humidity, lightning, power surges, structural failures surrounding the appliance, and acts of God. 	
<ul style="list-style-type: none"> ● Content losses of food or other content due to spoilage. ● Incidental or consequential damages ● Parts and labor costs for the following will not be considered as warranty: <ul style="list-style-type: none"> ● Evaporator doors, door springs, and/or frames. ● Inner door panels, door shelves, door rails, and/or door supports. ● Vegetable crispers. ● Light bulbs and/or plastic housing. ● Plastic cabinet liners. ● Punctured evaporator that voids the warranty on the complete sealed system. 	<ul style="list-style-type: none"> ● Shipping and handling costs associated with the replacement of the unit. ● Repairs performed by unauthorized servicers. ● Service calls that are related to external problems, such as abuse, misuse, inadequate electrical power, accidents, fire, floods, or any other acts of God. ● Failure of the product if it is used for other than its intended purpose. ● The warranty does not apply outside the Continental USA. ● Surcharges including but not limited to, any after hour, weekend, or holiday service calls, tolls, ferry trip charges, or mileage expense for service calls to remote areas.
In no event shall Avanti Products have any liability or responsibility whatsoever for damage to surrounding property, including cabinetry, floors, ceilings, and other structures and/or objects around the product. Also excluded from this warranty are scratches, nicks, minor dents, and other cosmetic damages on external surfaces and exposed parts; Products on which the serial numbers have been altered, defaced or removed; service visits for customer education, or visits where there is nothing wrong with the product; correction of installation problems (you are solely responsible for any structure and setting for the product, including all electrical, plumbing and/or other connecting facilities, for proper foundation/flooring, and for any alterations including without limitation cabinetry, walls, floors, shelving etc., as well as the resetting of breakers or fuses.	
<u>OUT OF WARRANTY PRODUCT</u>	
Avanti Products is under no obligation, at law or otherwise, to provide you with any concessions, including repairs, pro-rates, or product replacement, once this warranty has expired.	
<small>WARRANTY – REFRIGERATION - COMPRESSOR</small>	

INSTRUCCIONES EN ESPAÑOL

PRECAUCIÓN	Para reducir el riesgo de incendio, descarga eléctrica, o daño cuando use su electrodoméstico, siga las siguientes precauciones.
<ul style="list-style-type: none">• Lea todas las instrucciones antes de usar su electrodoméstico.• Peligro o Precaución: Existe el riesgo que los niños queden atrapados.• Niños atrapados o sofocamiento no son un problema del pasado. Los electrodomésticos son peligrosos aún si solo los deja en el garaje por un par de días.• Antes de desechar su electrodoméstico o refrigerador usado: quítele las puertas. Deje las repisas en su lugar para evitar que los niños se queden atrapados.• No permita que los niños manejen, jueguen o entren dentro del electrodoméstico.• No limpie su electrodoméstico con líquidos inflamables. Los gases pueden ocasionar fuego o una explosión.• No guarde ni use gasolina u otros líquidos inflamables cerca de este o de cualquier otro electrodoméstico. Los vapores pueden ocasionar fuego o explosión. <p style="text-align: center;">- <u>Guarde estas instrucciones</u> -</p>	

INSTRUCCIONES PARA LA INSTALACIÓN

Antes de usar su equipo

- Retire la envoltura interna y externa.
- Verifique que tenga las siguientes partes: 1 manual de instrucciones, 2 parillas en el refrigerador, 1 parilla en el congelador, 2 bandejas con una tapa de vidrio para vegetales y una llave tipo Allen.
- 2 piezas plásticas para cubrir agujeros (puerta reversible).
- Antes de conectar su electrodoméstico a la corriente eléctrica, ubíquelo en posición vertical sobre una superficie plana por lo menos por 2 horas. Esto reducirá la posibilidad de malfuncionamiento en el sistema de enfriamiento por el manipuleo durante el transporte.
- Limpie la superficie interior con agua tibia usando un trapo suave.

Instalación de su electrodoméstico

- Ubique su electrodoméstico en un piso que sea lo suficientemente fuerte para soportar su peso cuando este totalmente lleno o cargado. Para nivelar el electrodoméstico, ajuste las patas delanteras.
- Deje aproximadamente 5 pulgadas de espacio entre la parte trasera y los costados de su electrodoméstico, así permitirá la circulación de aire necesaria para enfriar el compresor.
- Mantenga su electrodoméstico alejado del aire caliente, vapor o líquidos que puedan salpicarlo, ya que la unidad podría averiarse.
- Los rayos solares directos pueden malograr la capa acrílica, y las fuentes de calor pueden ocasionar un aumento en el consumo eléctrico. Manténgalo lo más alejado posible del agua para prevenir algún choque eléctrico. Evite los sitios húmedos y los ambientes extremadamente fríos ya que esto puede afectar la eficiencia del enfriamiento de su electrodoméstico.
- Evite ubicar su electrodoméstico en áreas mojadas o muy húmedas.
- Conecte el electrodoméstico a un enchufe de pared exclusivo con conexión a tierra. Bajo ninguna razón se debe retirar la tercera punta del enchufe. Cualquier consulta con respecto a la energía y/o cable de tierra debe ser dirigida a un electricista certificado o autorizado por el Servicio Técnico de Avanti Products.

Conexión eléctrica

Este electrodoméstico debe ser conectado a tierra. En el caso que ocurra un corto circuito, la conexión a tierra reduce el riesgo de recibir un choque eléctrico ya que cuenta con un alambre para el escape de la corriente eléctrica. Este electrodoméstico está equipado con un enchufe que consta de tres puntas, la tercera punta es la conexión a tierra. Este enchufe debe ser insertado a un enchufe de pared que este correctamente instalado con la conexión a tierra.

ADVERTENCIA

- El uso inapropiado del enchufe a tierra puede desencadenar un choque eléctrico. Consulte a personal autorizado por Avanti Products si tiene alguna duda sobre las instrucciones o si tiene alguna consulta si el electrodoméstico está correctamente instalado a la corriente eléctrica y a tierra. Si el cordón del enchufe del electrodoméstico se encuentra dañado, debe ser reemplazado por el Servicio Técnico de Avanti Products.

- El cordón del enchufe está equipado con tres puntas que encajan perfectamente en un enchufe de pared standard para reducir el riesgo de un choque eléctrico.
- Bajo ninguna circunstancia corte o saque la tercera punta del enchufe que le proveemos ya que este es para que vaya conectado a tierra.
- No use una extensión.
- La corriente de este electrodoméstico es de 115/120 voltios, tiene una salida eléctrica de 60 Hz. y consta de un enchufe de tres puntas que va conectado al enchufe de pared.
- El cordón del enchufe debe ser asegurado atrás del electrodoméstico y no dejarlo expuesto para evitar accidentes.

COMO CAMBIAR LA DIRECCION DE APERTURA DE LA PUERTA

En caso de que necesite cambiar el lado de apertura de la puerta, por favor consulte al servicio pos-venta de su localidad.

ADVERTENCIA

No use agua hirviendo porque dañará las partes de plástico.

- Retire los alimentos del electrodoméstico y colóquelos en una caja térmica para conservarlos y protegerlos.

Control de temperatura del refrigerador

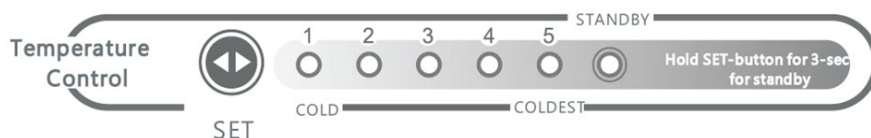

1 es frío
3 es NORMAL
5 es el más frío
Standby es APAGADO

La opción de Standby es apagado, se apagará todo el ciclo de enfriar pero no apagará la fuente de electricidad a la unidad..

Control de temperature del congelador

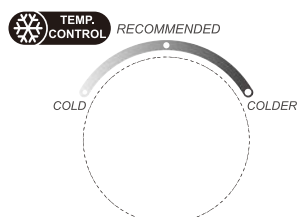

COLD is frío
Recommended es NORMAL
COLDER es el más frío

Como graduar la temperatura

Para ajustar la temperatura interna de su unidad, ajuste los controles considerando la temperatura ambiental.

Una vez conectada su unidad, mueva el control de la temperatura hacia la posición "COLDER" en el compartimiento del congelador y a la posición "5" en el refrigerador, por 4 horas.

Después muévelo a la posición "**Recommended**" en el compartimiento del congelador y a la posición "3" en el compartimiento del refrigerador.

Las posiciones en ambos controles funcionan de la siguiente manera:

En el compartimiento del refrigerador,
La posición "1" Menos Frío/ La posición "5" más Frío

En el compartimiento del congelador,
La posición "MIN" Menos Frío/ La posición "MAX" más Frío

Una vez transcurrida 4 horas, Usted deber reajustar los controles en ambos compartimientos a las temperaturas apropiadas a sus necesidades.

NOTA:

NO RECOMENDAMOS la instalación de la unidad donde la temperatura descienda de los 50 °F (13°C) o aumente sobre 110°F (43°C). El compresor no podrá mantener las temperaturas adecuadas dentro del refrigerador.

Para instalaciones donde las temperaturas bajarán por debajo de los 50°F (13°C); Ajuste el control de temperatura del congelador al ajuste "MÁS FRÍO". Esto mejorará las operaciones del refrigerador bajo estas condiciones.

CUIDADOS EN LOS PERIODOS DE AUSENCIA

- Para cortos períodos de ausencia (menos de 21 días) el congelador podrá quedar funcionando. Coloque el botón de control de temperaturas en la posición mínima.
- En períodos de ausencia más largos, se aconseja dejar el refrigerador limpio y desconectado.
- Retire todo lo que tenga adentro del refrigerador y haga el deshielo y la limpieza general. También retire las cubeteras, limpie bien y séquelas internamente.
- Deje la puerta entreabierta para penetre el aire y así evitar la formación de olores.

Compartimiento de su congelador

- Este compartimiento está diseñado para un período largo (3 meses) de almacenamiento de alimentos congelados.
- El tiempo de almacenamiento de los alimentos congelados varía y se recomienda almacenarlos solamente mientras esté vigente la fecha de expiración.
- Alimentos congelados preenvasados comercialmente deben ser almacenados de acuerdo con las indicaciones de su fabricante.
- Coloque los alimentos congelados dentro de su electrodoméstico inmediatamente después de comprarlos. Si hay indicaciones en el envase, sígalas cuidadosamente considerando el tiempo de almacenamiento.

CUIDADO Y MANTENIMIENTO

Limpiando su electrodoméstico

- Desconecte el electrodoméstico y retire los alimentos.
- Lave el interior con agua tibia y un trapo suave remojado en una solución de Bicarbonato de Sodio. La solución consiste en 2 cucharadas del referido compuesto químico y un litro de agua.
- Lave la canasta de almacenaje con un detergente suave.
- Las partes externas de su electrodoméstico deben ser limpiadas con un detergente suave y agua tibia.

ADVERTENCIA

Asegúrese de desconectar el electrodoméstico de la corriente eléctrica. Si no lo hace, puede ocasionar un choque eléctrico o herirse.

Si falla el suministro eléctrico

Usualmente la electricidad regresa en unas pocas horas sin afectar la temperatura de su electrodoméstico, siempre que la puerta no se abra muy frecuentemente. Si le va a faltar electricidad por un período de tiempo más largo, usted debe tomar los pasos apropiados para proteger sus alimentos.

Si usted sale de vacaciones

Retire todos los alimentos si va a estar ausente por un período largo; desconecte y limpie su electrodoméstico.

Deje la puerta del electrodoméstico ligeramente abierta para evitar la formación de mal olor y moho.

Reemplazando La Bombilla

Antes de cambiar la bombilla, desconecte el refrigerador de la electricidad.

1. Hale y desconecte la cubierta plástica.
2. Remueva la bombilla rotándola hacia la izquierda
3. Reemplace la bombilla con una equivalente de 15 vatios.
4. Vuelva a colocar la capa plástica.

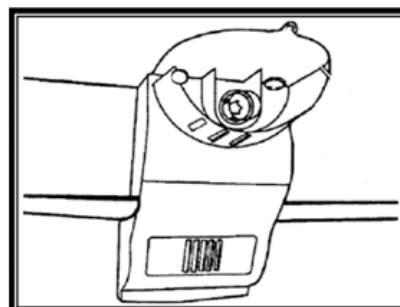

Para mover su electrodoméstico

- Retire los alimentos.
- Asegúrese de colocar cinta adhesiva a todo lo que se puede caer dentro de su electrodoméstico.
- Retire las patas para prevenir que se dañen.
- Selle las puertas con cinta adhesiva.
- Asegúrese que el electrodoméstico se mantenga parado durante el traslado.

Consejos para ahorrar energía

- Su electrodoméstico debe estar ubicado en el área más fría de la habitación, alejado de electrodomésticos que produzcan calor o conductos de aire caliente y lejos de los rayos solares.
- Los alimentos calientes deben estar a temperatura ambiental antes de colocarlos en el electrodoméstico. Si sobrecarga su electrodoméstico forzará al compresor a funcionar más tiempo del normal. Los alimentos que se congelan lentamente pierden calidad y se malogran.
- Asegúrese de envolver adecuadamente los alimentos y de secar los empaques o contenedores antes de colocarlos dentro del electrodoméstico. Colocarlos mojados ocasiona escarcha en el electrodoméstico.
- La canasta de almacenaje de su electrodoméstico no debe ser forrada con papel aluminio, papel de cera o papel toalla ya que esto interfiere con la circulación del aire frío restando eficiencia a su electrodoméstico.

REGISTRATION INFORMATION

Thank you for purchasing this fine Avanti product. Please fill out this form and return it to the following address within 100 days from the date of purchase and receive these important benefits:

**Avanti Products LLC.
P.O.Box 520604 – Miami, Florida 33152**

➤ **Protect your product:**

We will keep the model number and date of purchase of your new Avanti product on file to help you refer to this information in the event of an insurance claim such as fire or theft.

➤ **Promote better products:**

We value your input. Your responses will help us develop products designed to best meet your future needs.

------(detach here)-----

Avanti Registration Card

Name	Model #	Serial #
Address	Date Purchased	Store / Dealer Name
City State Zip	E-mail Address	
Area Code Phone Number	Occupation	
Did You Purchase An Additional Warranty	As your Primary Residence, Do You:	
<input type="checkbox"/> Extended <input type="checkbox"/> None	<input type="checkbox"/> Own <input type="checkbox"/> Rent	
Reason for Choosing This Avanti Product: Please indicate the most important factors That influenced your decision to purchase this product:	Your Age:	
<input type="checkbox"/> Price <input type="checkbox"/> Product Features <input type="checkbox"/> Avanti Reputation <input type="checkbox"/> Product Quality <input type="checkbox"/> Salesperson Recommendation <input type="checkbox"/> Other: _____ <input type="checkbox"/> Friend / Relative Recommendation <input type="checkbox"/> Warranty <input type="checkbox"/> Other: _____	<input type="checkbox"/> under 18 <input type="checkbox"/> 18-25 <input type="checkbox"/> 26-30 <input type="checkbox"/> 31-35 <input type="checkbox"/> 36-50 <input type="checkbox"/> over 50	
Comments:	Marital Status: <input type="checkbox"/> Married <input type="checkbox"/> Single	
	Is This Product Used In The: <input type="checkbox"/> Home <input type="checkbox"/> Business	
	How Did You Learn About This Product: <input type="checkbox"/> Advertising <input type="checkbox"/> In-Store Demo <input type="checkbox"/> Personal Demo	

