

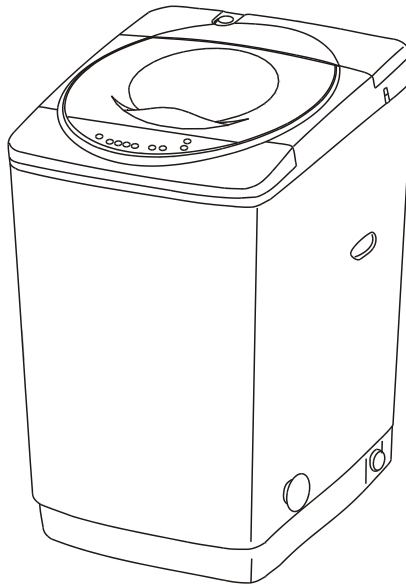

**INSTRUCTION MANUAL
MANUAL DE INSTRUCCIONES**

Model Numbers/ No. de Modelos: W798SS-1

**PORTABLE WASHER
LAVADORA PORTATIL**



BEFORE USE, PLEASE READ AND FOLLOW ALL SAFETY RULES AND OPERATING INSTRUCTIONS.

La sección en español empieza en la página 18.

Avanti has a policy of continuous improvement on its products and reserves the right to change materials and specifications without notice.

**Avanti Products, A Division of the Mackle Co., Inc.
P.O. Box 520604 - Miami, Florida 33152
www.avantiproducs.com**

TABLE OF CONTENTS

Help Us Help You	3
Parts and Features	4
Important Safety Instructions	5
Installation Instructions	5
Before Using Your Appliance	
Selecting a Location	
Adjusting the Adjustable Foot	
Installing the Noise Proof Plate	5 – 8
Connecting the Water Supply	
Water Connection	
Disconnecting the Water Inlet Hose	
Positioning the Drain Hose	
Electrical Connection	9
Control Panel	10
Operating Your Appliance	
Preparation	
Before Washing	
Operation Instructions	
Automatic Wash Programs	10 – 15
Manual Functions	
Functions	
Delay Start Instructions	
Children-Proof Setting	
Care and Maintenance	15
Cleaning Your Appliance	15
Troubleshooting Guide	16
Service for Your Appliance	16
Wiring Diagram	16
Your Avanti Products Warranty	17
Instrucciones en Español	18 - 26
Registration Information and Registration Card	27

HELP US HELP YOU...

Read this guide carefully.

It is intended to help you operate and maintain your new portable washer properly.

Keep it handy to answer your questions. If you don't understand something or you need more assistance, please call:

**Avanti Customer Service
800-220-5570**

Keep proof of original purchase date (such as your sales slip) with this guide to establish the warranty period.

Write down the model and serial numbers.

You'll find them on a plate located on the rear outside wall of the portable washer.

Please write these numbers here:

Date of Purchase

Model Number

Serial Number

Use these numbers in any correspondence or service calls concerning your portable washer.

If you received a damaged portable washer, immediately contact the dealer (or builder) that sold you the portable washer.

Save time and money. Before you call for service, check the Troubleshooting Guide. It lists causes of minor operating problems that you can correct yourself.

IF YOU NEED SERVICE

We're proud of our service and want you to be pleased. If for some reason you are not happy with the service you receive, here are some steps to follow for further assistance.

FIRST, contact the people who serviced your portable washer. Explain why you are not pleased. In most cases, this will solve the problem.

NEXT, if you are still not pleased, write all the details, including your telephone number, and send it to:

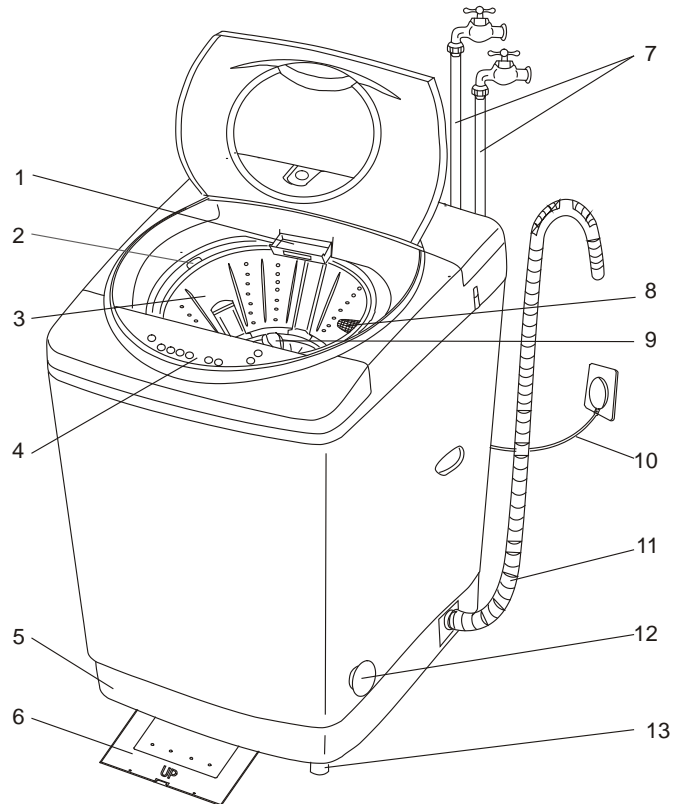

**Customer Service
Avanti Products
10880 NW 30 Street
Miami, FL 33172 USA**

PARTS & FEATURES



1. DETERGENT CASE
2. SOFTENER DISPENSER
3. INNER TUB
4. CONTROL PANEL
5. BASE
6. NOISE PROOF PLATE
7. INLET HOSE (2 PCS)
8. LINT FILTER
9. PULSATOR
10. POWER SUPPLY CORD
11. DRAIN HOSE (1 PC)
12. LEVEL ADJUSTABLE KNOB
13. ADJUSTABLE FOOT

ACCESSORIES

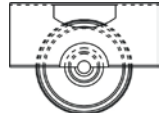
<p>INLET HOSE</p>  <p>2 PIECES</p>	<p>NOISE PROOF PLATE</p>  <p>1 PIECE</p>	<p>FAUCET ADAPTER</p>  <p>2 PIECES</p>	<p>CASTER</p>  <p>4 PIECES</p>
---	---	---	---

IMPORTANT SAFETY INSTRUCTIONS

⚡WARNING⚡	To reduce the risk of fire, electrical shock, or injury when using your portable washer, follow these basic precautions:
<ul style="list-style-type: none">• Read all instructions before using the portable washer.• Do not wash articles that have been previously cleaned in, washed in, soaked in, or spotted with gasoline, dry-cleaning solvents, or other flammable or explosive substances, as they give off vapors that could ignite or explode.• Do not add gasoline, dry-cleaning solvents, or other flammable or explosive substances to the wash water. These substances give off vapours that could ignite or explode.• Under certain conditions, hydrogen gas may be produced in a hot-water system that has not been used for 2 weeks or more. HYDROGEN GAS IS EXPLOSIVE. If the hot-water system has not been used for such a period, before using a washing machine, turn on all hot-water faucets and let water flow from each for several minutes. This will release any accumulated hydrogen gas. As the gas is flammable, do not smoke or use an open flame during this time.• DANGER or WARNING: Risk of child entrapment. Child entrapment and suffocation are not problems of the past. Junked or abandoned appliances are still dangerous . . . even if they will “just sit in the garage a few days.”• Before you throw away your old portable washer: Take off the lid.• Never allow children to operate, play with, or crawl inside the portable washer. Close supervision of children is necessary when the washer is used near children.• Do not reach into the washer if the agitator or inner tub is moving.• Do not tamper with controls.• Do not repair or replace any part of the washer or attempt any servicing unless specifically recommended in the user-maintenance instructions or in published user-repair instructions.• Never clean portable washer parts with flammable fluids. The fumes can create a fire hazard or explosion.• Do not place the washer in steamy rooms or where the washer is directly exposed to rain. Moisture may destroy the electrical insulation causing an electrical shock hazard.• Do not store, use gasoline, or any other flammable vapors and liquids in the vicinity of this or any other portable washer. The fumes can create a fire hazard or explosion.• If the power cord is damaged, it must be replaced by the manufacturer or its service agent or a similar qualified person in order to avoid a hazard. <p style="text-align: center;">-Save these instructions-</p>	

INSTALLATION INSTRUCTIONS

BEFORE USING YOUR PORTABLE WASHER

- Remove the exterior and interior packing.
- You will need the following tools:
 - Wrench
 - Pliers
 - Screwdriver
- Check to be sure you have all of the following parts:
 - 2 Inlet Hoses
 - 2 Faucet Adapters
 - 1 Noise Proof Plate With Screws
 - 4 Casters
- Remove shipping brace. Note - It should be saved and used (to prevent damage to washer components) whenever washer is moved or transported to a new location.
- Clean the interior surface with lukewarm water using a soft cloth.
- Allow 2 inches of space between the back and sides of the appliance.

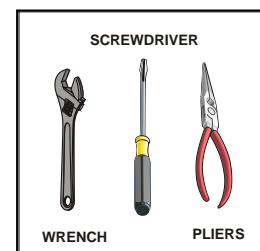

- Put your laundry into the washer evenly. Uneven laundry may cause noise or vibration.
- Don't use excessively hot water (50°C or more). Plastic parts may be deformed or damaged. Also, clothing may be deformed or bleached.
- Before washing, check all pockets. If nails or pins remain in pockets, they may damage the washer or clothes.
- Never splash water on the control panel.
- Plug the washer into an exclusive properly installed-grounded wall outlet. Do not under any circumstances cut or remove the third (ground) prong from the power cord. Any questions concerning power and/or grounding should be directed toward a certified electrician or an authorized Avanti Products service center.

SELECTING A LOCATION

Before you install the portable washer, select a location with the following characteristics:

- A hard level surface (if the surface is uneven, see Adjusting The Adjustable Foot).
- Away from direct sunlight. Direct sunlight may affect the acrylic coating, plastic and electrical components.
- Adequate ventilation.
- Away from sources of heat such as coal or gas. Make sure that the washing machine does not stand on its power cord. Ventilation openings must not be obstructed by carpeting when the portable washer is installed on a carpeted floor.

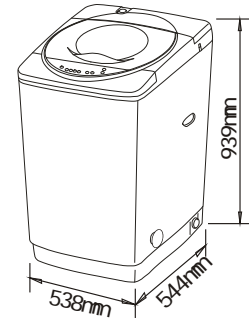

ADJUSTING THE ADJUSTABLE FOOT

If the floor is uneven adjust the adjustable foot (do not insert pieces of wood, or any other objects under the feet).

Loosen the adjustable foot by turning the level adjustable knob with your hand until it is at the desired height.

Tighten the adjustable foot by turning the level adjustable knob in the reverse direction.

Place the washer on a sturdy flat surface.

If the washer is placed on an uneven or weak surface, noise or vibration occurs (Allowable is 1°).

For portable applications, the washing machine comes equipped with four north/south casters that can easily be installed to assist in the movement of the machine to and from the sink. Lay the unit on its back. Install the casters into the bottom of the base as indicated.

Return the machine to the upright position. When the machine is positioned for operation set the height of the adjustment foot slightly higher than the front caster to prevent movement of the machine during wash and spin operation.

NOTE: *Not all movement will be totally eliminated, this is normal.*

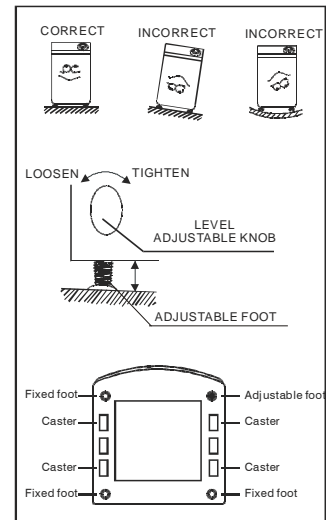

INSTALLING THE NOISE PROOF PLATE

Take the noise proof plate out of the package .

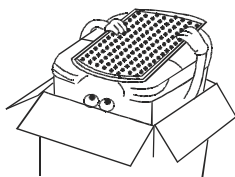

The opening of the noise proof plate is at the bottom of the machine.



Insert the noise proof plate into the washing machine base.

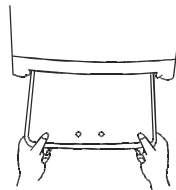

Lay down the machine and secure the noise proof plate by fastening the two set screws.

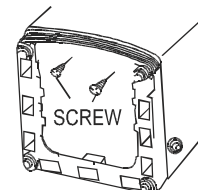

CONNECTING THE WATER SUPPLY HOSE

The water supply hose must be connected to the washing machine at one end and to the water faucet at the other. Do not stretch the water supply hose. If the hose is too short and you do not wish to move the water faucet, replace the hose with a longer, high-pressure hose.

Select appropriate faucet as shown in the figures below. If none of these faucets are available, use the faucet adapter provided.

The end of faucet spout should be longer than 10mm (0.4"), or the connector cannot be fixed properly. Water leakage could develop.

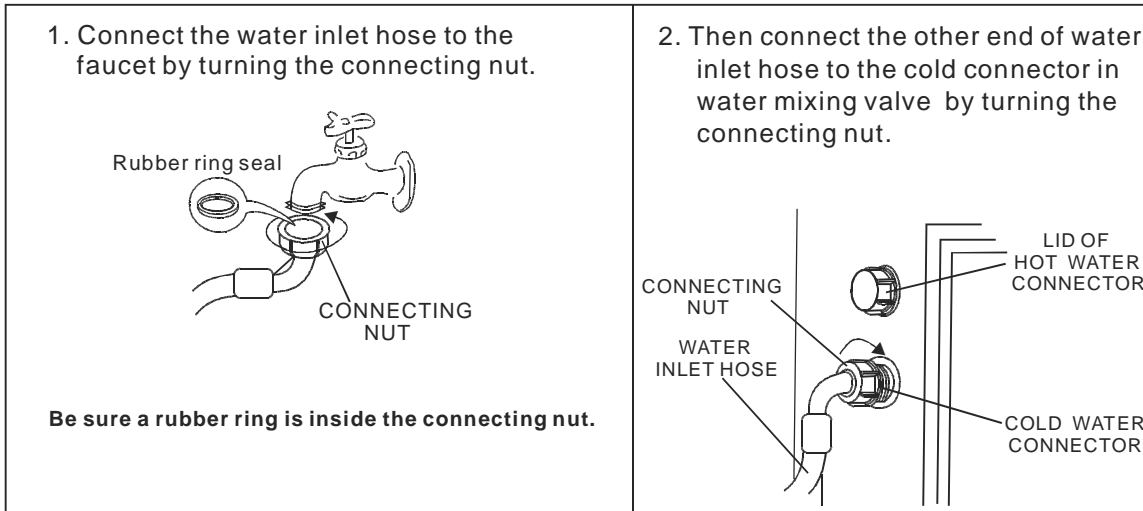

If you have both cold and hot water supplied, connect the inlet hoses by matching cold to cold and hot to hot.

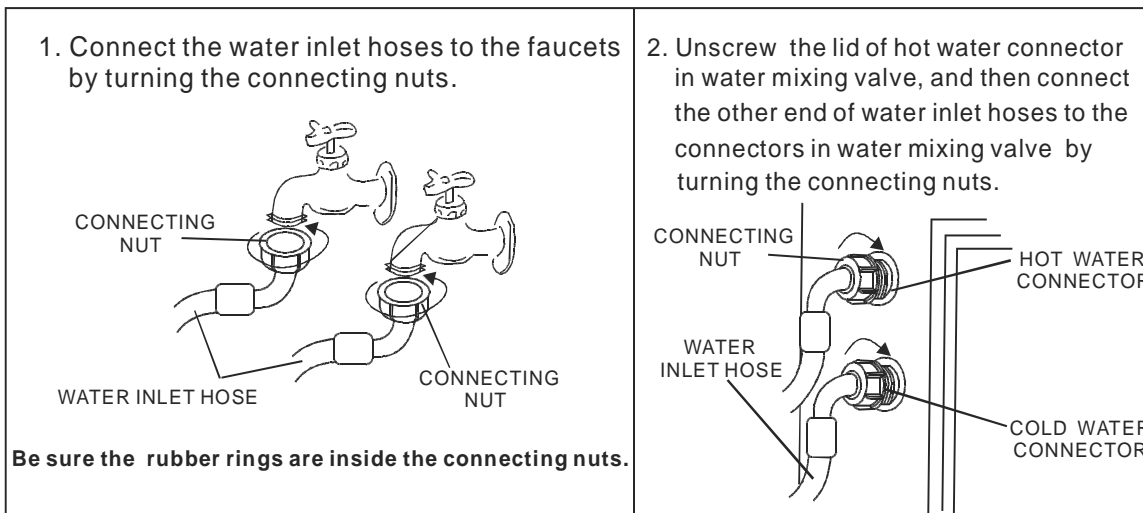

WATER CONNECTION

For normal kitchen-sink tap only use the inlet hose with cold water inlet.

Connect the inlet hose to the male hose thread adapter by turning it clockwise to be fixed tightly.

Make sure to insert the rubber ring enclosed. Then connect tightly to your sink.

Note: Some faucets may require you to also use the female hose thread adapter between the male adapter and your sink faucet as shown below. Make sure the rubber ring is inserted and connect to your sink.

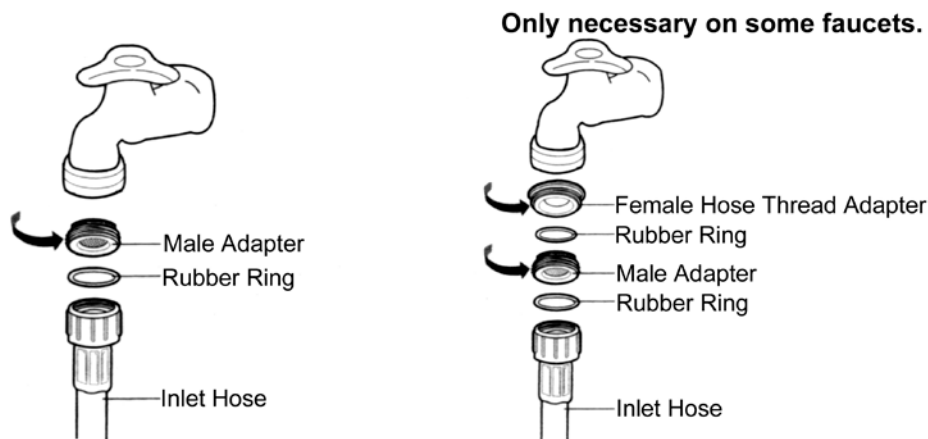

If water leaks from faucet connection or washer connection, turn off water and tighten fully using a wrench. Be careful not to over tighten and damage water connection. Turn on water supply and make sure no leaks are present.

DISCONNECTING THE INLET HOSE

Dismantling the hose directly may cause water to splash due to the possible high water pressure in the hose, even after the faucet has been turned off. Please take off the hose as per following steps, even if the faucet is closed:

- Turn off the faucet.
- Turn on the power and let the machine run for about 5 seconds then turn it off.
- Remove the connecting nuts from the faucet and washing machine.

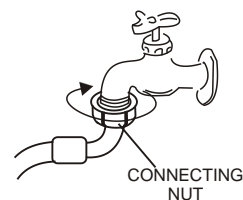

Note: If the washing machine is frequently used, it is not necessary to dismantle the inlet hose to avoid possible damage to the screws.

POSITIONING THE DRAIN HOSE

Connect the drain hose to the water outlet of the washing machine then fasten it with a pinchcork. Since only up drainage is available, drain hose can be hung in the basin or bathtub.

NOTE: The highest point of the drain hose must be in the height of 0.7-1.2m above floor level, otherwise, the washer cannot work normally.

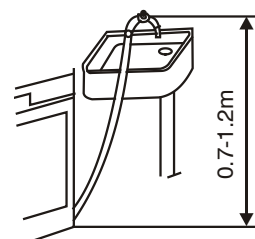

➤ **ELECTRICAL CONNECTION**

⚡ Warning ⚡

Improper use of the grounded plug can result in the risk of electrical shock. If the power cord is damaged, have it replaced by an authorized Avanti Products service center.

This appliance should be properly grounded for your safety. The power cord of this appliance is equipped with a three-prong plug which mates with standard three prong wall outlets to minimize the possibility of electrical shock.

Do not under any circumstances cut or remove the third ground prong from the power cord supplied. For personal safety, this appliance must be properly grounded.

This appliance requires a standard 115/120 Volt AC ~/60Hz electrical ground outlet with three-prong. Have the wall outlet and circuit checked by a qualified electrician to make sure the outlet is properly grounded. When a standard 2-prong wall outlet is encountered, it is your responsibility and obligation to have it replaced with a properly grounded 3-prong wall outlet.

The cord should be secured behind the appliance and not left exposed or dangling to prevent accidental injury.

The appliance should always be plugged into its own individual electrical outlet which has a voltage rating that matches the rating label on the appliance. This provides the best performance and also prevent overloading house wiring circuits that could cause a fire hazard from overheated. Never unplug the appliance by pulling the power cord. Always grip the plug firmly and pull straight out from the receptacle. Repair or replace immediately all power cords that have become frayed or otherwise damaged. Do not use a cord that shows cracks or abrasion damage along its length or at either end. When moving the appliance, be careful not to damage the power cord.

➤ **EXTENSION CORD**

Because of potential safety hazards under certain conditions, it is strongly recommended that you do not use an extension cord with this appliance. However, if you must use an extension cord it is absolutely necessary that it be a UL/CUL-Listed, 3-wire grounding type appliance extension cord having a grounding type plug and outlet and that the electrical rating of the cord be 115 volts and at least 10 amperes.

➤ **SURGE PROTECTOR**

Most electrical appliances use a series of electric control boards to operate. These boards are very susceptible to power surges and could be damaged or destroyed.

If the appliance is going to be used in an area or if your city / country is prone to power surges / outages; it is suggested that you use a power surge protector for all electrical devices / appliances you use. The surge protector that you select must have a surge block high enough to protect the appliance it is connected to. If you have any questions regarding the type and size of surge protector needed contact a licensed electrician in your area.

Damages due to power surges are not considered a manufacturer covered defect and will void your product warranty.

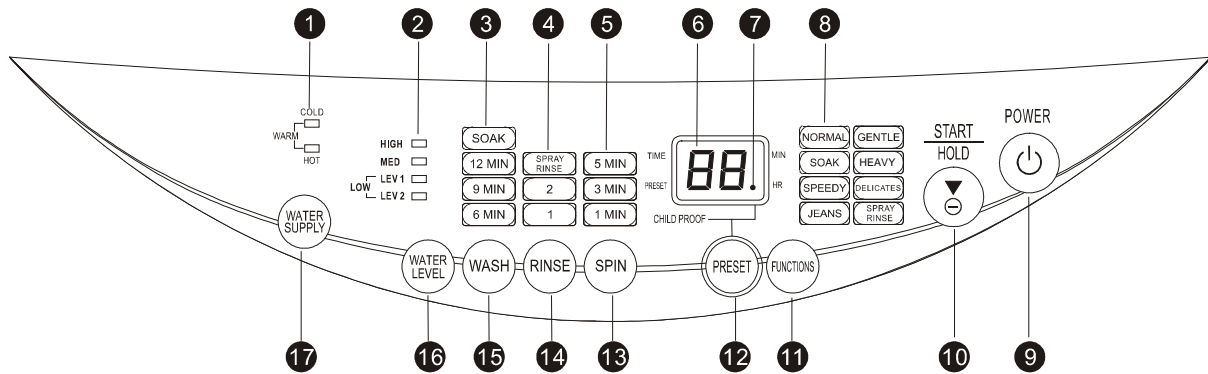

CONTROL PANEL



- | | |
|--------------------------------|--|
| 1. Water Temperature Indicator | 10. START/HOLD Button |
| 2. Water Level Indicator | 11. Function Selection Button |
| 3. Wash Time Indicator | 12. Preset Button |
| 4. Rinse Time Indicator | 13. Spin Time Selection Button |
| 5. Spin Time Indicator | 14. Rinse Time Selection Button |
| 6. LED Display | 15. Wash Time Selection Button |
| 7. Children-proof Indicator | 16. Water Level Selection Button |
| 8. Function Indicator | 17. Water Temperature Selection Button |
| 9. Power Button | |

OPERATING YOUR PORTABLE WASHER

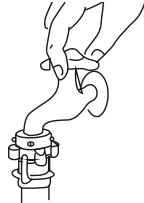
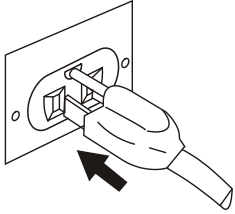
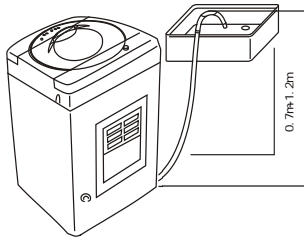
PREPARATION

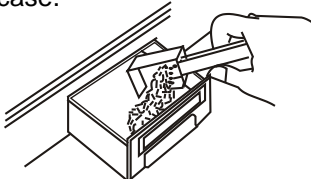
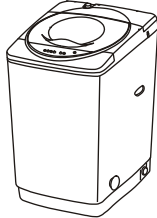
<p>1. Connect the water inlet hose to the water faucet. Don't switch on the power if the water pressure is lower than 0.05MPa and higher than 0.5MPa.</p> <p>2. Open the water faucet.</p> 	<p>3. Insert the plug into the socket. For safety the plug should have ground connection.</p> 	<p>4. Insert the end of drain hose into the hook shelf, and hang the drain hose over a drain outlet.</p> 
<p>5. Put the wash load into the tub evenly.</p> 	<p>6. Add the suitable quantity detergent into the detergent case.</p> 	<p>7. Close the lid. Otherwise the washer will not operate.</p> 

BEFORE WASHING

Prepare the wash load. Mix large and small articles in a load to get the best washing results. Drop articles loosely into the inner tub. Do not pack articles in or wrap them. Articles should move freely through the wash water for best cleaning results. Articles should rollover, sink and then reappear.

When washing very large articles, do not fill inner tub as full as with other loads. The water level in your washer should fit the size of your wash load. Small load will use lower water levels. There must be enough water in the inner tub to allow articles to move and turn over freely. Overloading the inner tub can result in poor washing and rinsing. Overloading may also cause wrinkling and tearing of articles.

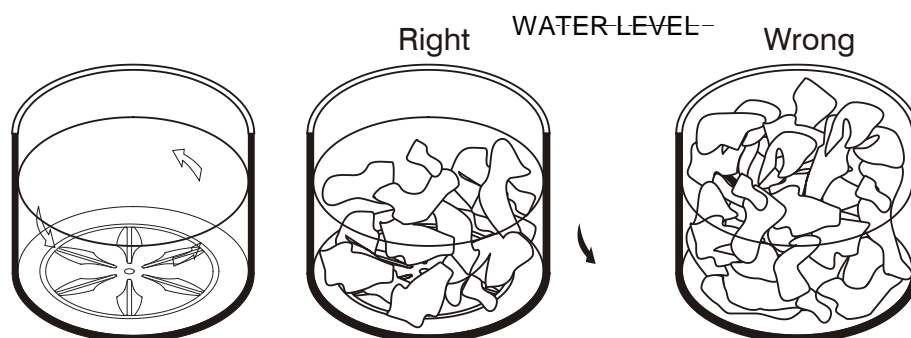

OPERATION INSTRUCTIONS

PRESS DOWN POWER BUTTON.

PRESS DOWN WATER LEVEL BUTTON.

Choose appropriate water level according to wash load quantity.

WATER TEMPERATURE CHOICE.

Press down the water temperature selection button, you can choose to inlet cold water or hot water. When the cold-water indicator and the hot-water indicator turn on simultaneously, which means you chose the warm water.

NOTE: The washer will provide a cold rinse in all TEMPERATURE settings.

IMPORTANT: A single cold hose system does not allow the washing machine to automatically (select) regulate incoming water temperatures to match those listed on the control panel such as WARM or HOT.

PRESS DOWN WASH TIME SELECTION BUTTON.

Press down wash time selection button to select the wash time. You can also press the button to select soak.

NOTE: When all indicators are OFF, the wash cycle is finished.

PRESS DOWN RINSE TIMES SELECT BUTTON.

Press this button to select the times of rinse. When SPRAY RINSE is selected, the washing machine will spray water to rinse firstly during rinse course.

NOTE: When all indicators are OFF, the rinse cycle is finished.

PRESS DOWN SPIN TIME SELECT BUTTON.

Press this button to select the time of spin.

NOTE: When all indicators are OFF, the spin cycle is finished.

IMPORTANT NOTE: You can select different WASH, RINSE and SPIN combinations according to your needs.

PRESS DOWN PRESET BUTTON.

Press this button for delay start setting and children-proof setting.

PRESS DOWN FUNCTIONS SELECTION BUTTON.

Choose the desired function and then the corresponding indicator blink.

PRESS DOWN START/HOLD BUTTON ONCE AND THE MACHINE WILL BEGIN OPERATION.

Please press this button to stop the normal operation, if it continues to work, press it again.

Water level can be reset during the normal operation. If the higher water level is selected, the machine will operate after refilling the water level selected.

AUTOMATIC WASH PROGRAMS**NORMAL** – For normal laundry

- Press down the power button.
- The NORMAL indicator will be ON. (NORMAL is the default program)
- Press the water supply button to select the water temperature.
- Press the water level button to select the appropriate water level setting. (The default water level is HIGH)
- Press the START/HOLD to start the course. And the LED display will show the remaining time of the entire course.

SOAK – For dirty laundry

- Press down the power button.
- Press the functions button to select the SOAK function until the SOAK indicator is ON.
- Press the water supply button to select the water temperature.
- Press the water level button to select the appropriate water level setting.
- Press the START/HOLD to start the course. And the LED display will show the remaining time of the entire course.

SPEEDY – For light dirty laundry

- Press down the power button.
- Press the functions button to select the SPEEDY function until the SPEEDY indicator is ON.
- Press the water supply button to select the water temperature.
- Press the water level button to select the appropriate water level setting. Press the START/HOLD to start the course. And the LED display will show the remaining time of the entire course.

JEANS – For massive laundry

- Press down the power button.
- Press the functions button to select the JEANS function until the JEANS indicator is ON.
- Press the water supply button to select the water temperature.
- Press the water level button to select the appropriate water level setting.
- Press the START/HOLD to start the course. And the LED display will show the remaining time of the entire course.

GENTLE – For elaborate laundry

- Press down the power button.
- Press the functions button to select the GENTLE function until the GENTLE indicator is ON.
- Press the water supply button to select the water temperature.
- Press the water level button to select the appropriate water level setting.
- Press the START/HOLD to start the course. And the LED display will show the remaining time of the entire course.

HEAVY – For big laundry

- Press down the power button.
- Press the functions button to select the HEAVY function until the HEAVY indicator is ON.

- Press the water supply button to select the water temperature.
- Press the water level button to select the appropriate water level setting.
- Press the START/HOLD to start the course. And the LED display will show the remaining time of the entire course.

DELICATES – For small laundry

- Press down the power button.
- Press the functions button to select the DELICATES function until the DELICATES indicator is ON.
- Press the water supply button to select the water temperature.
- Press the water level button to select the appropriate water level setting. (The default water level is LOW-LEV2)
- Press the START/HOLD to start the course. And the LED display will show the remaining time of the entire course.

SPRAY RINSE – For children laundry

- Press down the power button.
- Press the functions button to select the SPRAY RINSE function until the SPRAY RINSE indicator is ON.
- Press the water supply button to select the water temperature.
- Press the water level button to select the appropriate water level setting.
- Press the START/HOLD to start the course. And the LED display will show the remaining time of the entire course.

MANUAL FUNCTIONS

WASH ONLY

- Press down the power button.
- Press the functions button to select the appropriate program.
- Press the water supply button to select the water temperature.
- Press the water level button to select the appropriate water level setting.
- Press the wash button to select the wash time.
- Press the rinse button until all rinse indicators are OFF.
- Press the spin button until all spin indicators are OFF.
- Press the START/HOLD to start the course. And the LED display will show the remaining time of the entire course.

WASH AND RINSE

- Press down the power button.
- Press the functions button to select the appropriate program.
- Press the water supply button to select the water temperature.
- Press the water level button to select the appropriate water level setting.
- Press the wash button to select the wash time.
- Press the rinse button to select the rinse times.
- Press the spin button until all spin indicators are OFF.
- Press the START/HOLD to start the course. And the LED display will show the remaining time of the entire course.

RINSE AND SPIN

- Press down the power button.
- Press the water level button to select the appropriate water level setting.
- Press the wash button until all wash indicators are OFF.
- Press the rinse button to select the rinse times.
- Press the spin button to select the spin time.
- Press the START/HOLD to start the course. And the LED display will show the remaining time of the entire course.

SPIN ONLY

- Press down the power button.
- Press the wash button until all wash indicators are OFF.
- Press the rinse button until all rinse indicators are OFF.
- Press the spin button to select the spin time.
- Press the START/HOLD to start the course. And the LED display will show the remaining time of the entire course.

FUNCTIONS

Each wash set is programmed in the computer; see the details in the wash program chart.

FUNCTION	SOAK	WASH	RINSE	SPIN	TOTAL TIME (Approx.)
NORMAL		12 Min.	1 Cycle	5 Min.	35 Min.
SOAK	20 Min.	12 Min.	2 Cycles	5 Min.	66 Min.
SPEEDY		6 Min.	Spray Rinse + 1 Cycle	3 Min.	33 Min.
JEANS		12 Min.	Spray Rinse + 2 Cycles	5 Min.	52 Min.
GENTLE		12 Min.	2 Cycles	3 Min.	44 Min.
HEAVY		12 Min.	Spray Rinse + 2 Cycles	5 Min.	58 Min.
DELICATES		6 Min.	2 Cycles	3 Min.	38 Min.
SPRAY RINSE		12 Min.	Spray Rinse + 2 Cycles	5 Min.	58 Min.

Press down each button within 5 minutes since the program will reset the process group. Then press down STRAT/HOLD button to re-start the washing machine. If not, the washing machine will shut down automatically.

Close the lid, or the washing machine will not operate.

In case the unbalance of load triggers the safety switch when spinning, the washing machine will automatically refill water to adjust the balance.

Note:

- Clothes easily discolored should be washed separately so as to prevent inter-dyeing.
- If you want to change a selected program, please press the START/HOLD button first, then press the Program button before pushing START/HOLD button.
- When Rinse & Drain program is ON, do not use detergent.
- If you want to drain water during washing, press the START/HOLD button, then select Rinse and Drain program. Press START/HOLD button again to restart.

DELAY START SETTING

Select this course when you have to go out or do something else.

- Press down the power button.
- Load the washing machine and select the appropriate wash program.
- Press PRESET button continuously to select the delay start time. (From 1 hour to 24 hours)
- Close the lid completely.
- Press START/HOLD button to start the course.

CHILDREN-PROOF SETTING

Select the function, the program will hold the washing machine and give out alert voice once the lid is opened when washing. And the washing machine will automatically drain water and give alarm if the lid is not closed in 10 seconds. In case a child falls into the washing machine when he plays around, he will be in safe status.

- Press down the power button.
- Select the appropriate program and press START/HOLD button to start the washing machine.
- The washing machine buzzer will give out music and the digital indicator show **bb**. This time you must decide whether to select the function or not.

- Press the PRESET button to select the function and the dot indicator will be ON. If no, don't do anything.

NOTE: If you open the lid while the machine in running, all operations will be stopped within 7 seconds.

To resume operation, close the lid.

CARE AND MAINTENANCE

CLEANING YOUR PORTABLE WASHER

- Clean the surface of your portable washer regularly with soft fabric.
- Clean the inner tub regularly, especially immediately after starch or bleach operation.
- Clean the filter in the inlet valve or inlet hose regularly in order to prevent it from clogging.

1. Unplug the power cord.

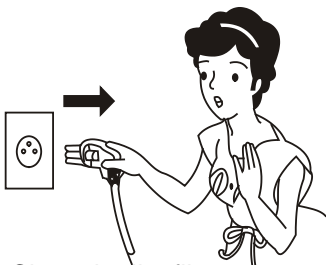

- Clean the lint filter.

2. Remove the inlet hose and clean the filter with a brush.

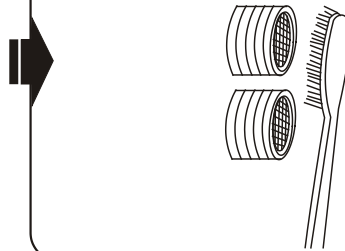

- Clean the surface of the washing machine with a soft cloth regularly.

- Clean the inner tub regularly, especially after washing starched or bleached laundry.

1. Pull upward to remove the lint filter.

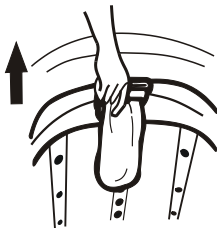

2. Clean and rinse it thoroughly.



3. Reinstall.

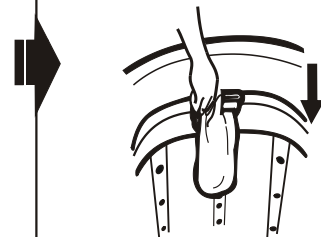

- Vacation time

1. Turn off the tap, remove water inlet hose, and let water drain out from the hose.

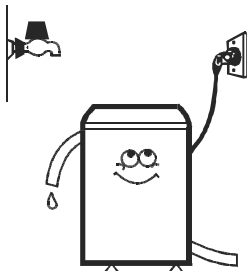

2. Set spin cycle for 1 minute.

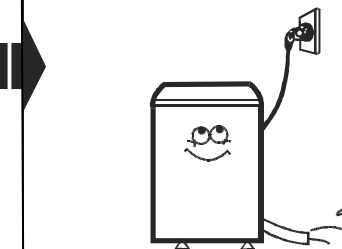

3. Unplug the power cord.

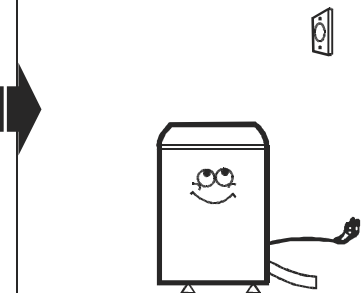

PROBLEMS WITH YOUR PORTABLE WASHER?

You can solve many common portable washer problems easily, saving you the cost of a possible service call. Try the suggestions below to see if you can solve the problem before calling the servicer.

TROUBLESHOOTING GUIDE

PROBLEM	POSSIBLE CAUSE
Washer does not operate.	Not plugged in. The circuit breaker tripped or a blown fuse. The lid is not closed. Make sure the water source is turned on.
No water or insufficient water supply.	The water source faucet is not turned on. The water source hose is frozen. The water intake hose is bent. The filter on the water intake hose is clogged.
The washing machine does not drain.	The drain hose is squashed or bent. The water hose mesh filter is clogged.
Washing machine vibrates or is too noisy.	Check to assure that the washer is level. The washing machine is touching another object. The laundry load is not balanced.
Washing machine does not spin.	The lid is not closed. The washer is not on a level surface.

SERVICE FOR YOUR PORTABLE WASHER

We are proud of our customer service organization and the network of professional service technicians that provide service on your Avanti portable washers. With the purchase of your Avanti portable washer, you can be confident that if you ever need additional information or assistance, the Avanti Products Customer Service Team will be here for you. Just call us toll-free.

AVANTI PRODUCTS CUSTOMER SERVICES

Product Information 800-323-5029	Whatever your questions are about our products, help is available.
Part Orders 800-220-5570	You may order parts and accessories that will be delivered directly to your home by personal check, money order, Master Card, or Visa.
In-Home Repair Service 800-220-5570	An Avanti Products authorized service center will provide expert repair service, scheduled at a time that is convenient for you. Our trained servicers know your portable washer inside and out.

WIRING DIAGRAM

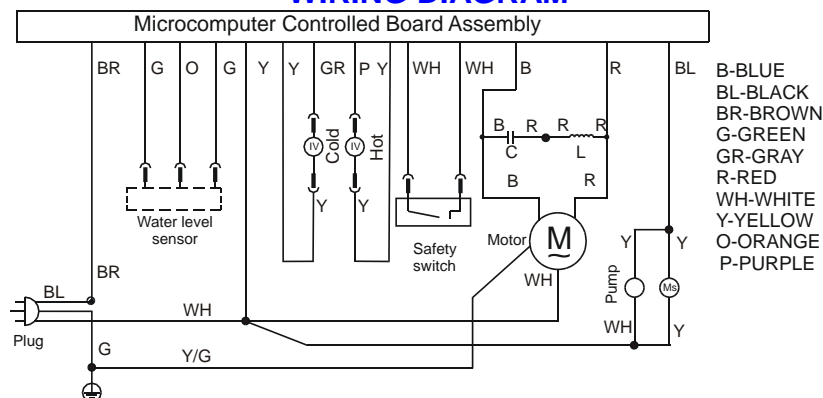

YOUR AVANTI PRODUCTS WARRANTY

Staple your sales receipt here. Proof of original purchase date is needed to obtain service under warranty.

WHAT IS COVERED

LIMITED ONE-YEAR WARRANTY

For one year from the date of purchase by the original owner, Avanti Products will, at its option, repair or replace any part of the appliance that proves to be defective in material or workmanship under normal use. During this period Avanti Products will provide all parts and labor necessary to correct such defects free of charge, so long as the appliance has been installed and operated in accordance with the written instructions in this manual. In rental or commercial use, the warranty period is 90 days.

LIMITED 5 YEAR WARRANTY ON PLASTIC TUB

After one year and until five years from date of purchase, Avanti will furnish a replacement plastic tub, for one which is defective in material or workmanship. You will be responsible for labor.

LIMITED 7 YEAR WARRANTY ON STAINLESS STEEL TUB

After one year and until seven years from date of purchase, Avanti will furnish a replacement stainless steel tub, for one which is defective in material or workmanship. You will be responsible for labor.

WHAT IS NOT COVERED

- Incidental or consequential damages.
- Service calls to:
- Correct the installation of your washer.
- Instruction on how to use your washer.
- Replace house fuses or incorrect house wiring or plumbing.
- Repairs performed by unauthorized servicers.
- Repairs when your washer is used in other than normal, single-family household use.
- Service calls that are related to external problems, such as abuse, misuse, inadequate electrical power, accidents, fire, floods, or acts of God.
- Failure of the product if it is used for other than its intended purpose.
- Pickup and delivery.
- Repairs caused by unauthorized modifications made to the appliance.
- This warranty does not apply outside the Continental U.S.A.

INSTRUCCIONES EN ESPAÑOL

LAVADORA AUTOMÁTICA DE ROPA

LEA TODAS LAS INSTRUCCIONES ANTES DE USAR ESTA LAVADORA Y GUARDE ESTE MANUAL EN UN LUGAR SEGURO PARA REFERENCIA FUTURA.

CONOCIENDO LAS PARTES DE SU LAVADORA AUTOMÁTICA

1. DISPENSADOR DEL DETERGENTE
2. DISPENSADOR DEL SUAVIZANTE DE ROPA
3. CILINDRO INTERNO DE LAVADO
4. PANEL DE CONTROL
5. BASE
6. PLATAFORMA A PRUEBA DE RUIDO. SE INSERTA EN LA BASE PARA REDUCIR EL NIVEL DE RUIDO Y ALEJA MALOS OLORES Y PLAGAS
7. MANGUERA DE SUMINISTRO DE AGUA / CIERRE LA LLAVE DESPUES DE LLENAR EL CILINDRO
8. FILTRO PARA PELUSAS
9. PROPULSOR
10. ENCHUFE Y CABLE DE ELECTRICIDAD
11. MANGUERA DE DRENAJE. TOME EN CUENTA QUE DURANTE EL FUNCIONAMIENTO DE LA LAVADORA, EL PUNTO MAS ALTO DE LA MANGUERA DE DRENAJE DEBE ESTAR ENTRE 70 Y 120CM SOBRE EL NIVEL DEL PISO
12. BOTON DE AJUSTE DE NIVEL
13. PATA DE AJUSTE

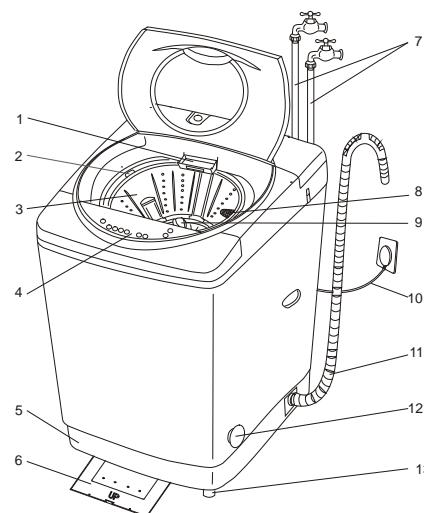

ACCESORIOS

MANGUERA DE SUMINISTRO DE AGUA	PLATAFORMA A PRUEBA DE RUIDO	ADAPTADOR	RUEDA
2 PIEZAS	1 PIEZA	2 PIEZAS	4 PIEZAS

ADVERTENCIA

SIGA ESTAS PRECAUCIONES BÁSICAS PARA REDUCIR EL RIESGO DE FUEGO, CORTO CIRCUITO O DAÑOS AL USAR SU LAVADORA PORTÁTIL.

- NO LIMPIE LA LAVADORA PORTÁTIL CON LÍQUIDOS INFLAMABLES. EL VAPOR PUEDE CREAR FUEGO O UNA EXPLOSIÓN
- LEA TODAS LAS INSTRUCCIONES ANTES DE USAR SU LAVADORA PORTÁTIL.
- **RIESGOS DE QUE LOS NIÑOS QUEDEN ATRAPADOS DENTRO DE LOS EQUIPOS NO SON PROBLEMAS DEL PASADO, NO PERMITA QUE OPEREN, JUEGUEN O ENTREN DENTRO DE LA LAVADORA. ANTES DE BOTAR O RETIRAR SU LAVADORA ASEGURESE DE QUITARLE LA PUERTA.**
- NO COLOQUE LA LAVADORA EN LUGARES HUMEDOS O EXPUESTA AL VAPOR O A LA LLUVIA. LA HUMEDAD PUEDE DESTRUIR EL AISLAMIENTO ELÉCTRICO, PUDIENDO CAUSAR UN CHOQUE ELÉCTRICO.
- NO ALMACENE, USE GASOLINA U OTRO LÍQUIDO GAS INFLAMABLE CERCA DE ESTA U OTRA LAVADORA PORTÁTIL. EL VAPOR PUEDE CREAR FUEGO O UNA EXPLOSIÓN.

INSTRUCCIONES DE INSTALACION

ANTES DE USAR SU LAVADORA

- REMUEVA EL EMPAQUE EXTERIOR E INTERIOR.
- NECESITARA LAS SIGUIENTES HERRAMIENTAS:
 - LLAVE INGLESA (O AJUSTABLE)
 - PINZAS (ALICATE)
 - DESTORNILLADOR
- ASEGURESE QUE TIENE LAS SIGUIENTES PIEZAS
 - 2 MANGUERAS CON ADAPTADORES PARA EL GRIFO
 - 1 PLACA PARA REDUCIR RUIDO (CON TORNILLOS)
- REMUEVA EL PROTECTOR.
- NOTA: DEBE GUARDAR Y USARLO CUANDO TENGA QUE MOVER O TRANSPORTAR LA LAVADORA A OTRO LUGAR.
- LIMPIE EL INTERIOR CON UN TRAPO SUAVE Y AGUA TIBIA.
- DEJE 2 PULGADAS DE ESPACIO ENTRE LA PARED Y LA LAVADORA.
- COLOQUE SU ROPA EN LA LAVADORA UNIFORMEMENTE. ROPA DESNIVELADA EN LA LAVADORA, PODRIA CAUSAR RUIDO O VIBRACION.
- NO USE AGUA DEMASIADO CALIENTE (50°C Ó MAS) YA QUE LAS PARTES PLASTICAS PODRIAN DEFORMARSE O DAÑARSE Y LA ROPA PODRIA DEFORMARSE O DESTEÑIRSE.
- ANTES DE LAVAR, REVISE Y VACIE TODOS LOS BOLSILLOS. CLAVOS, ALFILERES, ETC. ESTOS OBJETOS PUEDEN DAÑAR LA LAVADORA O SU ROPA.
- NO SALPIQUE AGUA AL PANEL DE CONTROL.
- CONECTE LA LAVADORA A UN ENCHUFE DE PARED EXCLUSIVO, CON CONEXION A TIERRA. BAJO NINGUNA CIRCUNSTANCIA REMUEVA O CORTE LA TERCERA PUNTA DEL ENCHUFE (CONEXION A TIERRA). DIRIJA CUALQUIER PREGUNTA RELACIONADA CON LA ELECTRICIDAD O CONEXION A TIERRA A UN ELECTRICISTA CERTIFICADO O A UN CENTRO DE SERVICIO AUTORIZADO POR AVANTI.

SELECCIONE UN LUGAR

ANTES DE INSTALAR SU LAVADORA, SELECCIONE UN LUGAR CON LAS SIGUIENTES CARACTERISTICAS:

- SUPERFICIE PLANA Y DURA (SI LA SUPERFICIE ES IRREGULAR, VEA "AJUSTE DE PATAS NIVELADORAS").
- LEJOS DE LA LUZ SOLAR DIRECTA. LA LUZ SOLAR DIRECTA PUEDE AFECTAR LA CAPA ACRILICA, COMPONENTES PLASTICOS Y ELECTRICOS.
- VENTILACION ADECUADA.
- LEJOS DE LAS FUENTES DE CALOR TALES COMO CARBON O GAS.
- ASEGURESE QUE LA LAVADORA NO ESTE APLASTANDO EL CORDON ELECTRICO. LAS APERTURAS DE VENTILACION DEBEN ESTAR LIBRES DE OBSTRUCCIONES TALES COMO ALFOMBRA.

AJUSTE DE PATAS NIVELADORAS

SI EL PISO ES IRREGULAR, AJUSTE LAS PATAS (NO INSERTE PEDAZOS DE MADERA U OTROS OBJETOS BAJO LAS PATAS).

DESENROSQUE EL TORNILLO GIRANDOLO CON LA MANO HASTA QUE LLEGUE A LA ALTURA DESEADA.

AJUSTE LA TUERCA CON LA LLAVE INGLESA.

COLOQUE LA LAVADORA EN UNA SUPERFICIE PLANA Y FIRME.

SI COLOCA LA LAVADORA EN UNA SUPERFICIE IRREGULAR O BLANDA, PODRIA CAUSAR DAÑO O VIBRACION.

PARA PORTABILIDAD, LA LAVADORA VIENE CON CUATRO RUEDAS FACILES DE INSTALAR, PARA AYUDAR AL MOVIMIENTO DE LA LAVADORA HACIA Y DESDE EL LAVADERO, ACUESTE LA UNIDAD SOBRE LA PARTE TRASERA E INSTALE LAS RUEDAS EN LA PARTE DE ABAJO DE LA BASE COMO MUESTRAN LAS FIGURAS, (DEBAJO EN ESTA PAGINA.)

REGRESE LA UNIDAD A LA POSICION VERTICAL. CUANDO LA MAQUINA ESTE COLOCADA PARA FUNCIONAMIENTO, AJUSTE LA PATAS A UNA ALTURA UN POCO MAYOR A LAS RUEDAS PARA EVITAR QUE LA LAVADORA SE MUEVA DURANTE EL LAVADO.

NOTA: AUN HACIENDO LO ANTERIOR, LA LAVADORA PODRIA MOVERSE. ESTO ES NORMAL.

INSERTE LA BANDEJA A PRUEBA DE RUIDO EN LA BASE DE LA LAVADORA

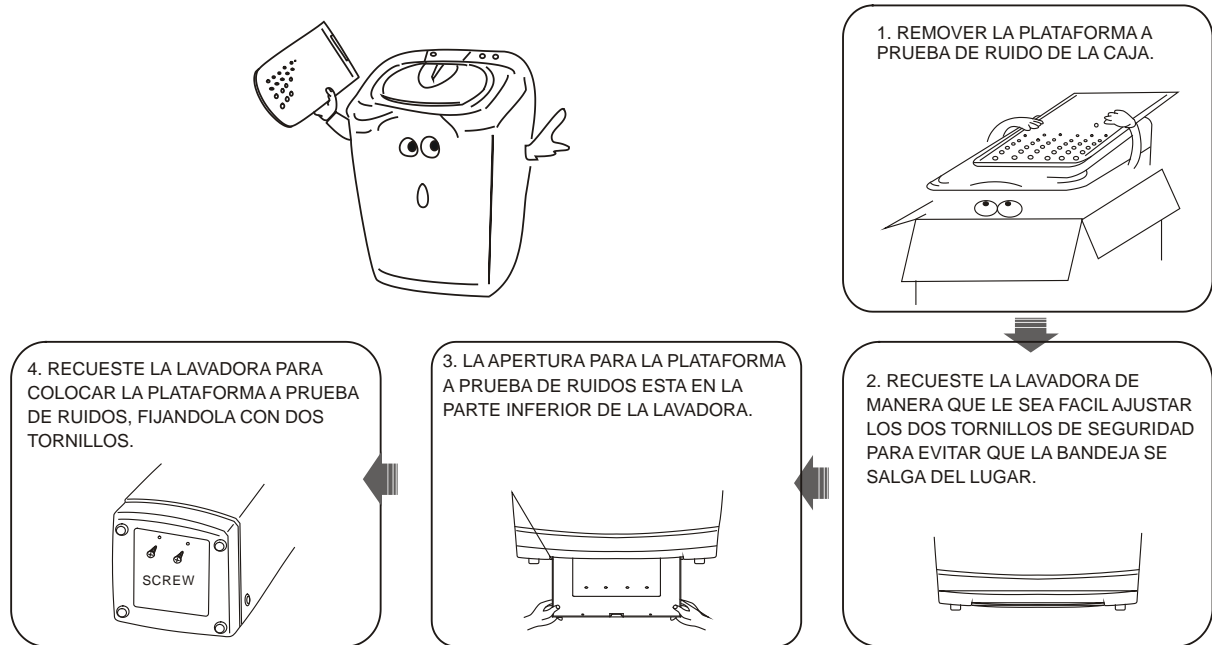

REMOVIENDO EL PROTECTOR
PARA PREVENIR QUE LA LAVADORA SE DAÑE, RECOMENDAMOS QUE GUARDE EL PROTECTOR Y LO USE CUANDO NECESITE MOVER O TRANSPORTAR SU LAVADORA,

Conexión Eléctrica

⚡ ADVERTENCIA ⚡

EL USO INAPROPIADO DEL ENCHUFE A TIERRA PUEDE OCASIONAR RIESGO DE UN CHOQUE ELECTRICO. SI EL CORDON SE DAÑASE, LLEVELO A UN CENTRO DE SERVICIO AUTORIZADO POR AVANTI PRODUCTS PARA QUE SE REEMPLACE.

- Para su seguridad, esta máquina de hacer hielo debe estar apropiadamente conectada a tierra. El cordón eléctrico de esta máquina de hacer hielo esta equipado con un enchufe de tres puntas, el cual encaja perfectamente en los receptáculos/enchufes de pared de tres puntas estándar, para minimizar la posibilidad de un choque eléctrico.
- Bajo ninguna circunstancia corte o retire la tercera punta (cable a tierra) del enchufe del cordón eléctrico.
- Nunca use un cable de extensión para conectar la unidad a la electricidad.
- Nunca use un adaptado con enchufe de solo 2 puntas.
- Si solo puede conectar la máquina de hacer hielo a un receptáculo/enchufe de pared de 2 puntas, comuníquese con un electricista calificado para que reemplace ese receptáculo/enchufe de pared por uno de 3 puntas, de acuerdo con los códigos de electricidad aplicables.
- Esta máquina de hacer hielo requiere un receptáculo/enchufe de pared de tres puntas estándar de 115/120 voltios a.c.~/60hz.
- Para prevenir cualquier daño físico o lesión, el cordón debe ser asegurado detrás de la máquina de hacer hielo y no estar expuesto o colgando.

Cable de Extensión

Debido al posible riesgo de seguridad causado bajo ciertas circunstancias, se recomienda firmemente que no use un cable de extensión para este electrodoméstico. Sin embargo, si no tiene otra opción mas que usar un cable de extensión, asegúrese que este sea un cable de extensión para electrodomésticos que este listado bajo UL/CUL, que tenga enchufe y receptáculo para enchufe de tres puntas (cable a tierra) y que la capacidad del cordón eléctrico sea de 115 voltios y no menos de 10 amperios.

PANEL DE CONTROL

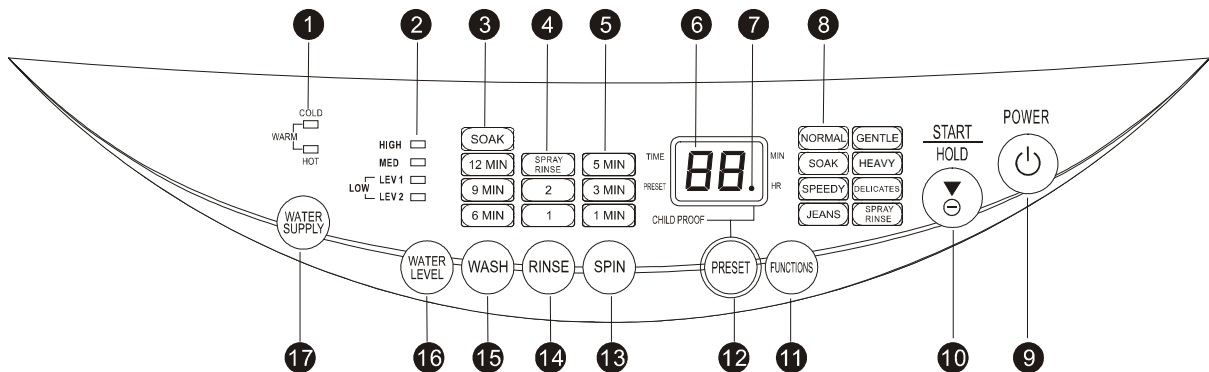

1	INDICADOR DE TEMPERATURA DEL AGUA	10	BOTON DE COMENZAR / PARAR LAVADO
2	INDICADOR DEL NIVEL DE AGUA	11	BOTON DE FUNCIONES/MODOS DE LAVADO
3	INDICADOR DEL MODO DE LAVADO	12	BOTO DE PREPROGRAMADO
4	INDICADOR DE FUNCION O PROCESO	13	BOTON DE CENTRIFUGADO
5	INICIO/PAUSA INICIA, DETIENE O REINICIA EL CICLO DE LAVADO	14	BOTON EN ENJUAGAR
6	PANTALLA ELECTRONICA	15	BOTON DE LAVADO
7	INDICADOR A PRUEBA DE NIÑOS	16	BOTON DE NIVEL DE AGUA
8	INDICADOR DE FUNCIONES	17	BOTON DE SUMINISTRO DE AGUA
9	BOTON DE PRENDER / APAGAR		

CONECTANDO LA MANGUERA DE SUMINISTRO DE AGUA
 UN EXTREMO DE LA MANGUERA PARA SUMINISTRO DE AGUA DEBE SER CONECTADO A LA LAVADORA Y EL OTRO EXTREMO AL GRIFO. NO ESTIRE LA MANGUERA DE SUMINISTRO DE AGUA. SI LA MANGUERA ES MUY CORTA Y NO DESEA MOVER EL GRIFO, REEMPLACE LA MANGUERA CON UNA MAS LARGA, DE ALTA PRESION.
 SELECCIONE EL GRIFO ADECUADO TAL COMO SE MUESTRA EN LAS FIGURAS ABAJO. SI NINGUNO DE ESTOS GRIFOS ESTA DISPONIBLE, USE EL ADAPTADOR INCLUIDO.
 EL LARGO DEL GRIFO DEBE SER DE MAS DE 10 MM (0.4"), DE OTRA MANERA EL CONECTOR NO PODRA SER AJUSTADO APROPIADAMENTE Y PODRIA PRODUCIR GOTEO.

IMPORTANTE: EN ESTA SITUACION, NO PROGRAME LA OPCION CALIENTE (HOT) COMO TEMPERATURA DE LAVADO.

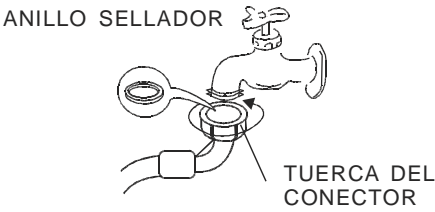
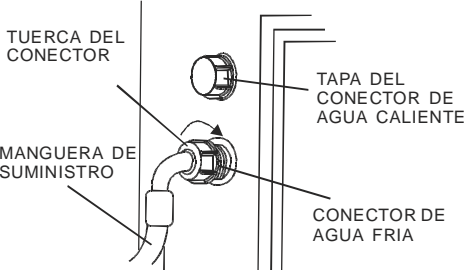
<p>1. CONECTE LA MANGUERA AL GRIFO DE SUMINISTRO DE AGUA A LA LLAVE GIRANDO LA TUERCA DEL CONECTOR DE LA MANGUERA HACIA LA DERECHA.</p>  <p>ANILLO SELLADOR</p> <p>TUERCA DEL CONECTOR</p> <p>ASEGURESE QUE EL ANILLO SELLADOR DE GOMA ESTE DENTRO DE LA TUERCA DEL CONECTOR DE LA MANGUERA.</p>	<p>2. REMUEVA LA TAPA DEL CONECTOR DE AGUA FRIA Y CONECTE EL OTRO EXTREMO DE LA MANGUERA DE SUMINISTRO DE AGUA CONECTOR DE AGUA A EL FRIA EN LA VALVULA MEZCLADORA DE AGUA. GIRANDO LA TUERCA DEL CONECTOR HACIA LA DERECHA.</p>  <p>TUERCA DEL CONECTOR</p> <p>TAPA DEL CONECTOR DE AGUA CALIENTE</p> <p>MANGUERA DE SUMINISTRO</p> <p>CONECTOR DE AGUA FRIA</p>
--	--

SI USTED TIENE LAS LLAVES DE SUMINISTRO DE AGUA POR SEPARADO (CALIENTE Y FRIA), CONECTE LA MANGUERA A LA LLAVE DE AGUA FRIA Y AL CONECTOR DE AGUA FRIA EN LA VALVULA MEZCLADORA DE AGUA. HAGA LO MISMO CON EL AGUA CALIENTE Y LA SEGUNDA MANGUERA.

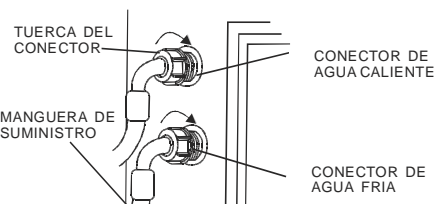
<p>1. CONECTE LAS MANGUERAS DE SUMINISTRO DE AGUA A LOS GRIFOS GIRANDO LAS TUERCAS DE LOS CONECTORES DE LAS MANGUERAS HACIA LA DERECHA.</p>  <p>TUERCA DEL CONECTOR</p> <p>MANGUERA DE SUMINISTRO</p> <p>TUERCA DEL CONECTOR</p> <p>ASEGURESE DE COLOCAR EL ANILLO SELLADOR DENTRO DE LAS TUERCAS DE LOS CONECTORES DE LAS MANGUERAS.</p>	<p>2. REMUEVA LAS TAPAS DE LOS CONECTORES DE AGUA FRIA Y CALIENTE DE LA UNIDAD Y CONECTE LOS OTROS EXTREMOS DE LAS MANGUERAS DE SUMINISTRO DE AGUA A LOS CONECTORES DE AGUA RESPECTIVOS EN LA VALVULA MEZCLADORA DE AGUA GIRANDO LAS TUERCAS DE LOS CONECTORES HACIA LA DERECHA.</p>  <p>TUERCA DEL CONECTOR</p> <p>MANGUERA DE SUMINISTRO</p> <p>CONECTOR DE AGUA CALIENTE</p> <p>CONECTOR DE AGUA FRIA</p>
--	--

DESCONECTANDO LA MANGUERA DE SUMINISTRO DE AGUA

DEBIDO A LA ALTA PRESION DE LA LLAVE AUN CUANDO ESTA CERRADA, RECOMENDAMOS DESCONECTAR LA MANGUERA, YA QUE PODRIA CAUSAR GOTEO O SALPICADURA. PARA EVITARLO SIGA ESTAS INSTRUCCIONES:

1. CIERRE LA LLAVE DEL AGUA
2. ENCIENDA LA LAVADORA
3. APAGUELA LUEGO DE 5 SEGUNDOS (APROXIMADAMENTE)
4. RETIRE LAS MANGUERAS GIRANDO LAS TUERCAS DEL CONECTOR HACIA LA IZQUIERDA

SI LA LAVADORA ES USADA FRECUENTEMENTE, NO RETIRE LAS CONEXIONES PARA EVITAR POSIBLES DAÑOS.

COLOCANDO LA MANGUERA DE DRENAJE

CONECTE LA MANGUERA DE DRENAJE A LA SALIDA DE AGUA DE LA LAVADORA Y AJUSTELA CON UNA GRAMPA AJUSTABLE. COMO PUEDE DRENAR HACIA ARRIBA O HACIA ABAJO, LA MANGUERA DE DRENAJE PUEDE SER COLOCADA EN EL PISO, EL BAÑO O LA BAÑERA, SIEMPRE QUE LA ALTURA NO SEA MAYOR A 70 CM.

EL PUNTO MAS ALTO DE LA MANGUERA DE DRENAJE DEBE SER 70 – 120 CM SOBRE EL NIVEL DEL PISO, DE LO CONTRARIO LA LAVADORA NO PODRA FUNCIONAR CORRECTAMENTE.

MODO DE EMPLEO

PREPARACION

1. CONECTE LA MANGUERA AL GRIFO DE SUMINISTRO DE AGUA.
 2. ABRA EL GRIFO DE SUMINISTRO DE AGUA. NO ENCIENDA LA LAVADORA SI LA PRESION ES MENOR A 0.02MPA O MAYOR A 0.5MPA.
 3. CONECTE EL CABLE DE ELECTRICIDAD EN EL TOMACORRIENTE. POR SU SEGURIDAD EL TOMACORRIENTE DEBE TENER UNA CONEXION PARA EL CABLE DE TIERRA.
 4. INSERTE EL EXTREMO DE LA MANGUERA DE DRENAJE EN LA PLATAFORMA DE CONEXION. CUELQUE EL OTRO EXTREMO DE LA MANGUERA EN UN RECIPIENTE DE DRENAJE (TINA DEL BAÑO, LAVADERO, ETC.)
 5. COLOQUE LA CARGA DE ROPA A LAVAR DENTRO DEL CILINDRO Y CIERRE LA TAPA. LA FUNCION DE LAVADO PUEDE CONTINUAR CON LA TAPA ABIERTA, PERO ES MEJOR CERRARLA ANTES QUE EMPIECE LA FUNCION DE SECADO (CENTRIFUGA).
 6. AÑADA UNA CANTIDAD ADECUADA DE DETERGENTE EN EL DISPENSADOR
- COLOQUE LOS ARTICULOS A LAVAR EN EL CILINDRO INTERNO Y CIERRE LA TAPA DE LA LAVADORA. EL CICLO DE LAVADO SE PUEDE REALIZAR CON LA PUERTA ABIERTA, A DIFERENCIA DEL CICLO DE SECADO (CENTRIFUGA) EN QUE LA PUERTA DEBE ESTAR CERRADA.

INSTRUCCIONES PARA OPERAR LA LAVADORA

AVISO: Si Ud. abra la tapa mientras que la lavadora está funcionando, la lavadora parará de funcionar en 7 segundos.

En cuanto Ud. cierre la tapa, la lavadora volverá a funcionar normalmente.

ENCENDIDO (POWER).

NIVEL DE AGUA (WATER LEVEL):

PRESIONE EL BOTON HASTA QUE SE ILUMINE EL NIVEL DE AGUA APROPIADO PARA LA CANTIDAD DE ROPA QUE VA A LAVAR.

TEMPERATURA DEL AGUA:

PRESIONE EL BOTON COLD PARA AGUA FRIA O HOT PARA CALIENTE. SI AMBAS LUCES SE ILUMINAN, SIGNIFICA QUE ESCOGIO AGUA TIBIA.

NOTA: EL ENJUAGUE ES SIEMPRE CON AGUA FRIA.

IMPORTANTE: PARA PODER SELECCIONAR LA TEMPERATURA, UD. DEBE CONTAR CON DOS ENTRADAS DE AGUA, UNA PARA AGUA FRIA Y OTRA PARA CALIENTE.

PROGRAMAS DE LAVADO (PROGRAM):

PRESIONE HASTA QUE SE ILUMINE EL PROGRAMA DESEADO, DE ACUERDO A LA CARGA DE ROPA QUE VAYA A LAVAR.

FUNCION (FUNCTION):

PRESIONE EL BOTON FUNCTION HASTA QUE SE ILUMINE LA FUNCION DESEADA.

INICIAR / DETENER (START/STOP):

PRESIONE EL BOTON START/STOP UNA VEZ PARA INICIAR EL FUNCIONAMIENTO. PARA DETENERLO, PRESIONE START/STOP NUEVAMENTE. SI CONTINUA FUNCIONANDO, PRESIONELO OTRA VEZ.

EL NIVEL DE AGUA PUEDE SER MODIFICADO DURANTE LA OPERACIÓN. SI DESEA UN NIVEL MAS ALTO DE AGUA, LA LAVADORA EMPEZARA A FUNCIONAR UNA VEZ QUE HAYA LLEGADO AL NIVEL DE AGUA DESEADO.

ANTES DE LAVAR

PREPARE LA CARGA DE ROPA A LAVAR. MEZCLE PIEZAS PEQUEÑAS Y GRANDES PARA OBTENER MEJORES RESULTADOS. DEPOSITE LAS PIEZAS DENTRO DEL CILINDRO. NO EMPAQUE LAS PIEZAS NI LAS ENVUELVA. LAS PIEZAS DEBEN MOVERSE LIBREMENTE DENTRO DEL AGUA PARA OBTENER MEJORES RESULTADOS.

LAS PIEZAS DEBEN RODAR, HUNDIRSE Y REAPARECER.

CUANDO LAVE PIEZAS MUY GRANDES, NO LLENE MUCHO EL CILINDRO DE AGUA. EL NIVEL DEL AGUA EN LA LAVADORA NO DEBE SOBREPASAR EL NIVEL DE LA ROPA. CARGAS DE ROPA PEQUEÑAS NECESITAN MENOS AGUA. DEBE HABER SUFICIENTE AGUA EN EL CILINDRO COMO PARA QUE LAS PIEZAS SE MUEVAN LIBREMENTE.

SOBRECARGAR LA LAVADORA PUEDE RESULTAR EN UN MAL LAVADO Y ENJUAGUE. LA SOBRECARGA PUEDE CAUSAR QUE LA ROPA SE ARRUGUE O QUE SE HALE.

DIBUJO:

NIVEL DE AGUA

CORRECTO

INCORRECTO)

FUNCIONES

LAS SIGUIENTES FUNCIONES DE LAVADO ESTAN PROGRAMADAS EN LA COMPUTADORA

FUNCIONE	REMOJO	LAVADO	ENJUAGUE	CENTRIFUGADO	FINALIZAR
NORMAL		12 MIN	1 CICLO	5 MIN	39 MIN
REMOJO	20 MIN	12 MIN	2 CICLOS	5 MIN	66 MIN
RAPIDO		6 MIN	1 CICLO	3 MIN	33 MIN
JEANS		12 MIN	2 CICLOS	5 MIN	52 MIN
SUAVE		12 MIN	2 CICLOS	3 MIN	44 MIN
FORZUDO		12 MIN	2 CICLOS	5 MIN	58 MIN
SEDAS		6 MIN	2 CICLOS	3 MIN	38 MIN
ENJUAGUE		12 MIN	2 CICLOS	5 MIN	58 MIN

CUENTA CON 5 MINUTOS PARA ELEGIR Y PRESIONAR EL(LOS) BOTON(ES) PARA PROGRAMAR EL MODO DE LAVADO.

LUEGO PRESIONE "START/PAUSE" PARA REINICIAR LA LAVADORA. DE LO CONTRARIO, LA LAVADORA SE APAGARA AUTOMATICAMENTE.

PARA EVITAR RUIDOS MOLESTOS DURANTE EL SECADO, CIERRE LA TAPA DE LA LAVADORA.

NOTA

LAS PIEZAS DE ROPA DE COLORES QUE DESTIÑEN DEBEN SER LAVADAS POR SEPARADO PARA EVITAR QUE MANCHEN OTRAS PIEZAS.

- SI DESEA CAMBIAR EL PROGRAMA SELECCIONADO, PRESIONE EL BOTON "START/STOP", LUEGO PRESIONE EL BOTON DEL PROGRAMA DESEADO. NUEVAMENTE PRESIONE EL BOTON "START/STOP".
- NO AÑADA DETERGENTE PARA EL CICLO DE ENJUAGUE Y DESAGÜE.
- SI DESEA BOTAR EL AGUA DURANTE EL CICLO DE LAVADO, PRESIONE EL BOTON "START/STOP", LUEGO PRESIONE EL BOTON DE "RINSE". NUEVAMENTE PRESIONE EL BOTON "START/STOP".

MANTENIMIENTO

LIMPIE REGULARMENTE LA SUPERFICIE DE SU LAVADORA CON UN PAÑO SUAVE.

LIMPIE EL CILINDRO INTERNO DE LAVADO CON UN PAÑO SUAVE, ESPECIALMENTE DESPUES DE LAVAR CON ALMIDON O CLORO.

LIMPIE EL FILTRO QUE SE ENCUENTRA EN LA VALVULA DE SUMINISTRO DE AGUA PARA PREVENIR POSIBLES OBSTRUCCIONES.

1. DESCONECTE EL ENCHUFE.
2. RETIRE LA MANGUERA DE SUMINISTRO DE AGUA Y LIMPIE EL FILTRO CON UN CEPILLO.

LIMPIANDO EL FILTRO DE PELUSAS

1. SAQUE EL FILTRO HALANDOLO HACIA ARRIBA. LAVE Y ENJUAGUE EL FILTRO CUIDADOSAMENTE. REINSTALE EL FILTRO NUEVAMENTE.

MANTENIMIENTO DE INVIERNO

1. CIERRE LA LLAVE DEL AGUA, DESCONECTE LAS MANGUERAS DE SUMINISTRO DE AGUA Y DEJELA DRENAR POR COMPLETO.
2. ACTIVE EL CICLO DE SECADO POR UN MINUTO.
3. APAGUE LA LAVADORA Y DESCONECTELA DE LA ELECTRICIDAD.

SI TIENE PROBLEMAS CON SU LAVADORA PORTATIL UD. PUEDE RESOLVER MUCHOS PROBLEMAS FACILMENTE, AHORRANDOSE EL COSTO DEL SERVICIO TECNICO. PRUEBE LAS SIGUIENTES SUGERENCIAS PARA VER SI PUEDE RESOLVER LOS PROBLEMAS, ANTES DE LLAMAR AL SERVICIO TECNICO.

GUIA PARA LA SOLUCION DE PROBLEMAS

PROBLEMA	REVISAR
LA LAVADORA NO FUNCIONA	VERIFIQUE QUE ESTE CONECTADA A LA ELECTRICIDAD. REVISE LA CAJA DE FUSIBLES EN SU CASA. LA LLAVE DE AGUA PUEDE ESTAR CERRADA.
NO ENTRA AGUA O EL NIVEL ES MUY BAJO	LA LLAVE DE AGUA PUEDE ESTAR CERRADA. LA MANGUERA DE ENTRADA DEL AGUA ESTA CONGELADA O PUEDE ESTAR DOBLADA. EL FILTRO EN EL CONECTOR DE LA LLAVE O LA VALVULA DE SUMINISTRO PUEDEN ESTAR OBSTRUIDOS.
LA LAVADORA NO DESAGUA	LA MANGUERA DE DESAGÜE ESTA OBSTRUIDA O APLASTADA. EL FILTRO DE LA MANGUERA DE DESAGÜE PUEDE ESTAR OBSTRUIDO.
LA LAVADORA VIBRA O HACE MUCHO RUIDO	VERIFIQUE QUE LA LAVADORA ESTE NIVELADA. LA LAVADORA ESTA TOCANDO OTRO OBJETO, SEPARELA. LA CARGA DE ROPA NO ESTA BIEN DISTRIBUIDA.

ADVERTENCIA

EL CABLE DE ELECTRICIDAD DEBE SER DESCONECTADO DESPUES DE USAR LA LAVADORA
USE DETERGENTE EN POLVO DE POCA ESPUMA
NO PERMITA QUE LOS NIÑOS JUEGUEN CON LA LAVADORA

Registration Information

Thank you for purchasing this fine Avanti product. Please fill out this form and return it to the following address within 100 days from the date of purchase and receive these important benefits:

Avanti Products, A Division of The Mackle Co., Inc.
P.O.Box 520604 – Miami, Florida 33152

➤ **Protect your product:**

We will keep the model number and date of purchase of your new Avanti product on file to help you refer to this information in the event of an insurance claim such as fire or theft.

➤ **Promote better products:**

We value your input. Your responses will help us develop products designed to best meet your future needs.

------(detach here)-----

Avanti Registration Card

Name	Model #	Serial #
Address	Date Purchased	Store / Dealer Name
City State Zip	E-mail Address	
Area Code Phone Number	Occupation	
Did You Purchase An Additional Warranty <input type="checkbox"/> Extended <input type="checkbox"/> None	As your Primary Residence, Do You: <input type="checkbox"/> Own <input type="checkbox"/> Rent	
Reason for Choosing This Avanti Product: Please indicate the most important factors That influenced your decision to purchase this product:	Your Age: <input type="checkbox"/> under 18 <input type="checkbox"/> 18-25 <input type="checkbox"/> 26-30 <input type="checkbox"/> 31-35 <input type="checkbox"/> 36-50 <input type="checkbox"/> over 50	
<input type="checkbox"/> Price <input type="checkbox"/> Product Features <input type="checkbox"/> Avanti Reputation <input type="checkbox"/> Product Quality <input type="checkbox"/> Salesperson Recommendation <input type="checkbox"/> Other: _____ <input type="checkbox"/> Friend / Relative Recommendation <input type="checkbox"/> Warranty <input type="checkbox"/> Other: _____	Marital Status: <input type="checkbox"/> Married <input type="checkbox"/> Single	
Comments: <hr style="border: 0; border-top: 1px solid black; margin: 5px 0;"/> <hr style="border: 0; border-top: 1px solid black; margin: 5px 0;"/>	Is This Product Used In The: <input type="checkbox"/> Home <input type="checkbox"/> Business	
	How Did You Learn About This Product: <input type="checkbox"/> Advertising <input type="checkbox"/> In-Store Demo <input type="checkbox"/> Personal Demo	

