

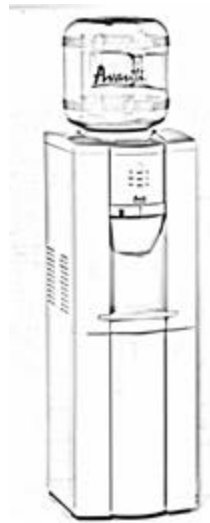

**MANUAL DE INSTRUCCIONES / INSTRUCTION MANUAL
DISPENSADOR DE AGUA FRIA Y CALIENTE / WATER DISPENSER**

Número de Modelo / Model Number:

WDP69



PRECAUCION:

ANTES DE USARSE, LEA ESTAS INSTRUCCIONES Y SIGA LAS REGLAS DE SEGURIDAD.

La sección en español empieza en la página 12.

Avanti has a policy of continuous improvement on its products and reserves the right to change materials and specifications without notice.

La política de Avanti es la de tener mejoras continuas en sus productos y se reserva el derecho de cambiar los materiales y especificaciones sin notificación alguna.

**Avanti Products
P.O. Box 520604 - Miami, Florida 33152
www.avantiproducts.com**

Table of Contents

Help Us Help You _____	3
Parts And Features _____	4
Important Safety Instructions _____	5
Installation Guidelines _____	5
Before Using Your Water Dispenser _____	5
Operating Your Water Dispenser _____	6
Care And Maintenance _____	7
Taking The Dispenser Out Of Service _____	7
How To Secure Your Unit To The Wall _____	8
Troubleshooting Guide _____	9
Your Avanti Products Warranty _____	10
Wiring Diagram _____	11
Spanish Section _____	12-15

IF YOU NEED SERVICE

We're proud of our service and want you to be pleased. If for some reason you are not happy with the service you receive, here are some steps to follow for further assistance.

FIRST, contact the people who serviced your appliance. Explain why you are not pleased. In most cases, this will solve the problem.

NEXT, if you are still not pleased, write all the details, including your telephone number, and send it to:

**Customer Service
Avanti Products
10880 NW 30 Street
Miami, FL 33172**

HELP US HELP YOU...

Read this guide carefully.

It is intended to help you operate and maintain your new water dispenser properly.

Keep it handy to answer your questions. If you don't understand something or you need more help, please call:

Avanti Customer Service

800-220-5570

Keep proof of original purchase date (such as your sales slip) with this guide to establish the warranty period.

Write down the model and serial numbers.

You'll find them on a label located on the back side of the unit.

Please write these numbers here:

Date of Purchase

Model Number

Serial Number

Use these numbers in any correspondence or service calls concerning your water dispenser.

If you received a damaged water dispenser, immediately contact the dealer (or builder) that sold you the water dispenser.

Save time and money. Before you call for service, check the Trouble Shooting Guide. It lists causes of minor operating problems that you can correct yourself.

PARTS AND FEATURES

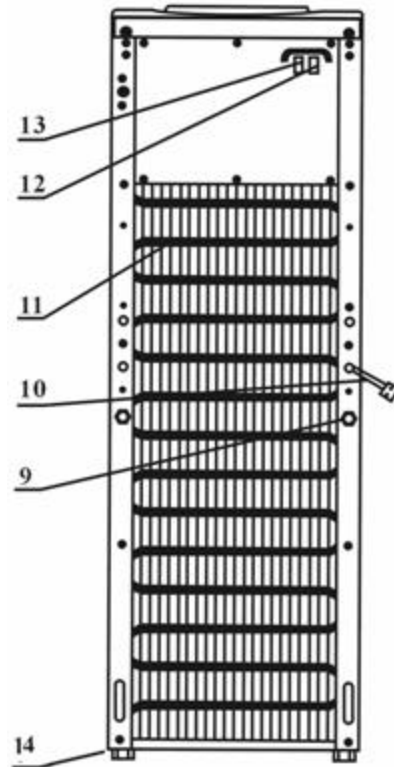
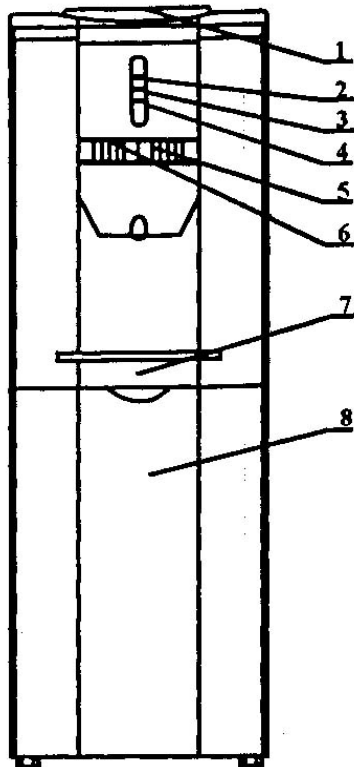

1. WATER INTAKE
2. HEATING INDICATOR (RED)
3. POWER INDICATOR (YELLOW)
4. COOLING INDICATOR (GREEN)
5. COLD WATER FAUCET (BLUE)
6. HOT WATER FAUCET/CHILD GUARD (RED)
7. REMOVABLE DRIP TRAY

8. STORAGE COMPARTMENT
9. HOT WATER DRAIN
10. POWER CORD
11. CONDENSER COILS
12. HEATING SWITCH (RED)
13. COOLING SWITCH (GREEN)
14. LEGS

Important Safety Instructions



WARNING

To reduce the risk of fire, electrical shock, or injury when using your appliance, follow these basic precautions:

- ? Read all instructions before using the water dispenser.
- ? Never clean parts with flammable fluids. The fumes can create a fire hazard or explosion.
- ? Do not store or use gasoline or any other flammable vapors and liquids in the vicinity of this or any other water dispenser. The fumes can create a fire hazard or explosion.
- ? Do not plug unit into receptacle until you ensure the water tank switches are off.

-Save these instructions-

INSTALLATION GUIDELINES:

- ? Remove the exterior and interior packing.
- ? Place your appliance on a floor that is strong enough to support the dispenser when it is fully loaded. The unit is provided with four plastic feet, if it does not sit level on the floor, adjust the front feet to level the unit well on the floor.
- ? Locate the appliance away from direct sunlight and sources of heat (stove, heater, radiator, etc.). Direct sunlight may affect the acrylic coating and heat sources may increase electrical consumption. Extreme cold ambient temperatures may also cause the appliance not to perform properly.
- ? Allow 2 inches of space between the water dispenser and the wall, which allows for proper air circulation to cool the compressor.
- ? Plug the appliance into an exclusive properly installed-grounded wall outlet. Do not cut or remove the third (ground) prong from the power cord under any circumstances. Any questions concerning power and/or grounding should be directed toward a certified electrician or an authorized Avanti Products service center.
- ? This water dispenser is not recommended for outdoor use.
- ? Do not locate the dispenser in area where the temperature may fall below freezing (32° F).
- ? Keep area around dispenser free of dust and dirt.
- ? Keep the reserve supply of water bottles away from excessive heat and light.
- ? Never unplug the water cooler, except for maintenance.

OPERATION INSTRUCTIONS:

Before Using Your Water Dispenser

- ? Check to be sure the following parts are included:
 - ✍ Instruction manual
 - ✍ 2 extra cup dispenser cabinet plugs
 - ✍ 2 extra drain seals
 - ✍ Accessories order form.
 - ✍ 2 brackets
- ✍ Before connecting the appliance to the power source, let it stand upright for approximately 2 hours. This will reduce the possibility of a malfunction in the cooling system from handling during transportation.
- ? The water dispenser is pre-cleaned at the factory but the reservoir and water lines must be flushed with fresh water before use as follows:
 - ? Keep the unit unplugged.
 - ? Fill water tank with tap water full to capacity. Wait for 5 minutes until water settles.

- ? Press the hot water faucet button until water comes out, then release it.
- ? Plug the dispenser into the electrical outlet. Both heating and cooling indicator lights on front will light up at first. We are ready to complete the first cycle. In order to do that, wait for the hot water indicator light to go off first (approximately 10 minutes), then wait for the cold water indicator light to go off (another 40 minutes, approximately).
- ? Unplug the dispenser from the electrical outlet. Proceed to drain the water from the faucets one at a time until no more water remains. (Note: To facilitate this operation, use a large container).
- ? Then, drain any water left in the tanks by opening the drain plug located on the back, until it drains completely.
- ? Proceed to close the drain cap. Also make sure both faucet buttons are released.
- ? Place the 5-gallon bottle of water on the water intake, allow water to stand for approximately one minute.
- ? Press the water faucet buttons to insure water flows from both faucets.
- ? Plug dispenser into the electrical outlet.
- ? Now you are ready to use your water dispenser.

NOTE: Your water dispenser has been cleaned and sanitized before leaving the factory, but in case a taste problem develops, place two tablespoons of baking soda and add tap water. Fill water tank again and repeat basic operations previously outlined, except turn the switch market hot "OFF" to avoid leaving residues in hot water tank.

ATTENTION:

If you do not plan to use the water heating function for more than three days, we recommend that you turn the hot switch to the "OFF" position.

 **WARNING** 

IMPROPER USE OF THE GROUNDED PLUG CAN RESULT IN THE RISK OF ELECTRICAL SHOCK. IF THE POWER CORD IS DAMAGED, HAVE IT REPLACED BY AN AUTHORIZED AVANTI PRODUCTS SERVICE CENTER.

OPERATING YOUR WATER DISPENSER

Steps To Replace Water Bottles

- ? Use a clean cloth to wipe off neck of bottle.
- ? Remove cap.
- ? Carefully lift bottle (approx. 40 lbs.) using your legs and not your back. Do not place hands on opening of bottle while placing in reservoir.
- ? Insert the water bottle on the water intake over reservoir opening so it settles properly on it.
- ? Wipe off any water which may have splashed on dispenser top.

When a new bottle is installed you must open the hot water faucet and remove no less than 4 full cups of water to insure the water flows properly and the water reservoir is at the proper level.

Cold Water Control

Turn the cooling switch (13) on. The green indicator (4) will be lit and the process begins. When the water reaches the right temperature the green light goes off automatically.

Hot Water Control

Turn heating switch (12) on, the red indicator (2) will be lit and the unit will begin to heat the water. When

When the water reaches the right temperature the red light goes off automatically. When the temperature goes down to approx. 80° C (176° F), the red indicator will glow again and another heating process starts.

NOTE:
THE HOT WATER FAUCET HAS A CHILD-SAFETY GUARD ATTACHMENT.

To get hot water:

- ? Slide safety button on faucet up.
- ? Continue holding safety button while pushing in faucet as long as water is being dispensed.
- ? When faucet is released, make sure to return it to the original position.

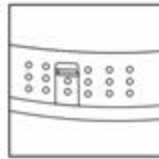

✍ Cup Dispenser (Optional)

A cup dispenser may be installed by using the mounting holes (covered with plastic caps) located near the top of the right side panel of the cooler. The cup dispenser comes equipped with a mounting bracket and screws and may be ordered by completing the enclosed order form provided with your instruction manual.

CARE AND MAINTENANCE

- ? Wash the inside of the reservoir with a warm water and baking soda solution. The solution should be about 2 tablespoons of baking soda to a quart of water.
- ? The drip tray and water faucets should be cleaned with mild detergent and warm water.
- ? At regular intervals or once a month inspect the coils located across the back of the dispenser. Vacuum accumulation of dust or clean it with a hard brush.

TAKING DISPENSER OUT OF SERVICE

- ? If the water dispenser will not be used for a long period of time, unplug the power cord from the wall outlet.
- ? Drain the water through the faucets.
- ? Turn the switch marked "HOT" to the "OFF" position.
- ? Drain the water from the tanks by removing the plug from the back of the dispenser.

WARNING—THE WATER COMING OUT OF THE BACK SIDE MARKED "HOT" MAY BE SCOLDING.

- ✍ Unit should not be transported on the sides. Place it upright if possible and cover it with a blanket.

Installation instructions on how to secure your Avanti unit to the wall

- 1- Attach the mounting brackets provided, into the pre-drilled holes located at the back of the unit side panels (see picture 2A) by using the self-tap screws provided.
- 2- After both brackets are properly installed, use the other end of the bracket to assist in aligning the holes to be drilled on the wall as follows:
Measure the center of the bracket mounting hole and the ground (see picture 2A), and measure the distance between the center of both brackets mounting holes (see picture 2B). Both of the above measurements will give you the exact location for drilling the holes on the wall where the unit will be secured.
- 3- Please be aware that when securing these brackets to the wall, different types of bolts may be used, depending on the different types of wall construction (these bolts are not included).
If you are not able to obtain the measurements as explained above, you can also mount and secure both brackets to the unit. Move the unit to your desired location and mark the wall using the holes at the other end of the bracket.

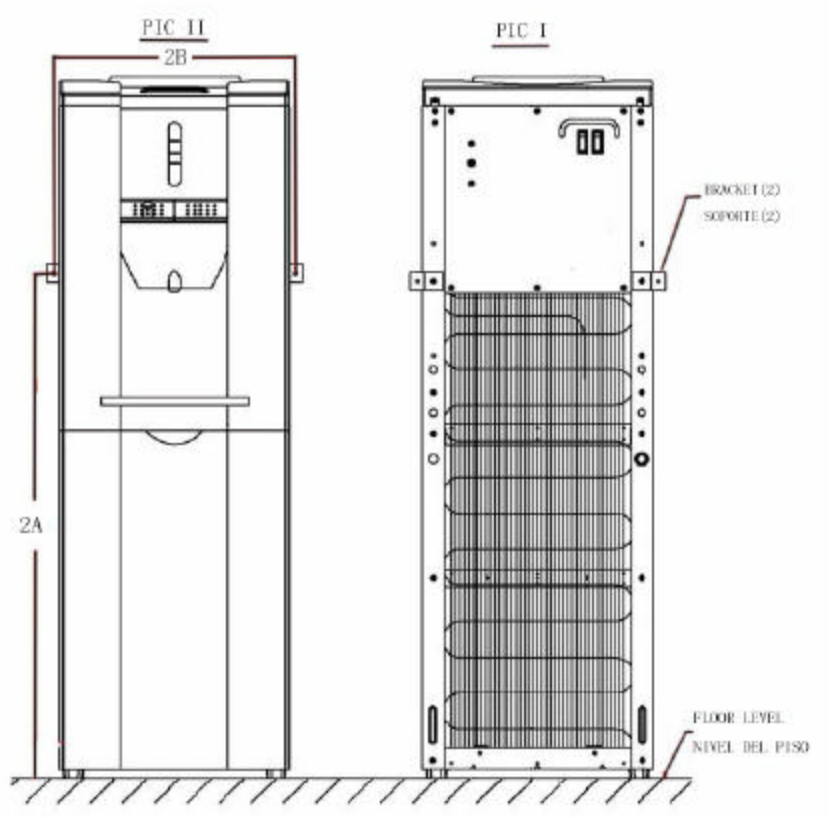

PROBLEMS WITH YOUR WATER DISPENSER?

You can solve many common water dispenser problems easily, saving you the cost of a possible service call. Try the suggestions outlined below to see if you can solve the problem before calling the servicer.

TROUBLESHOOTING GUIDE

PROBLEM	POSSIBLE CAUSE
Water dispenser does not operate.	Not plugged in. The circuit breaker tripped or a blown fuse.
Water cooler is not cold enough.	Check to be sure the cold switch on the back is ON. The water dispenser does not have the correct clearances.
Water dispenser hot water is not hot enough.	Check to be sure the hot switch on the back is ON.
Compressor turns on and off frequently.	The room temperature is hotter than normal. The temperature control is not set correctly. The water dispenser does not have the correct clearances.
Vibrations.	Check to assure that the water dispenser is level.
The water dispenser seems to make too much noise.	The rattling noise may come from the flow of the refrigerant, which is normal. As each cycle ends, you may hear gurgling sounds caused by the flow of refrigerant in your water dispenser. Contraction and expansion of the inside walls may cause popping and crackling noises. The water dispenser is not level.

SERVICE FOR YOUR WATER DISPENSER

We are proud of our customer service organization and the network of professional service technicians that provide service on your Avanti appliances. With the purchase of your Avanti appliance, you can be confident that if you ever need additional information or assistance, the Avanti Products Customer Service Team will be here for you. Just call us toll-free.

AVANTI PRODUCTS CUSTOMER SERVICES

Product Information 800-323-5029	Whatever your questions are about our products, help is available.
Part Orders 800-220-5570	You may order parts and accessories that will be delivered directly to your home, by personal check, money order, Master Card, or Visa.
In-Home Repair Service 800-220-5570	An Avanti Products authorized service center will provide expert repair service, scheduled at a time that is convenient for you. Our trained servicers know your appliance inside and out.

YOUR Avanti Products WARRANTY (Valid only in U.S.A)

Staple your sales receipt here. Proof of original purchase date is needed to obtain service under warranty.

WHAT IS COVERED

LIMITED ONE-YEAR WARRANTY

For one year from the date of purchase by the original owner, Avanti Products will, at its option, repair or replace any part of the appliance which proves to be defective in material or workmanship under normal use. During this period Avanti Products will provide all parts and labor necessary to correct such defects free of charge, so long as the appliance has been installed and operated in accordance with the written instructions in this manual. In rental or commercial use, the warranty period is 90 days.

LIMITED SECOND THROUGH FIFTH YEAR WARRANTY

For the second through the fifth year from date of original purchase, Avanti Products will provide a replacement compressor free of charge due to a failure. You are responsible for the service labor and freight charges. In rental or commercial use, the limited compressor warranty is one year and nine months. Cost to move the appliance to the servicer's shop and back to the user's home, as may be required, are the user's responsibility.

WHAT IS NOT COVERED

- ? Incidental or consequential damages.
- ? Parts and labor costs for the following will not be considered as warranty:
 - ? Light bulbs and/or plastic housing.
 - ? Plastic cabinet liners.
 - ? Punctured evaporator that voids the warranty on the complete sealed system.
 - ? Replacement of house fuses or resetting circuit breakers.
- ? Repairs performed by unauthorized servicers.
- ? Service calls that do not involve defects in material or workmanship such as customer education, or proper installation.
- ? Service calls that are related to external problems, such as abuse, misuse, inadequate electrical power, accidents, fire, floods, or acts of God.
- ? Failure of the product if it is used for other than its intended purpose.
- ? This warranty does not apply outside the continental U.S.A.

WIRING DIAGRAM / DIAGRAMA DE CABLEADO

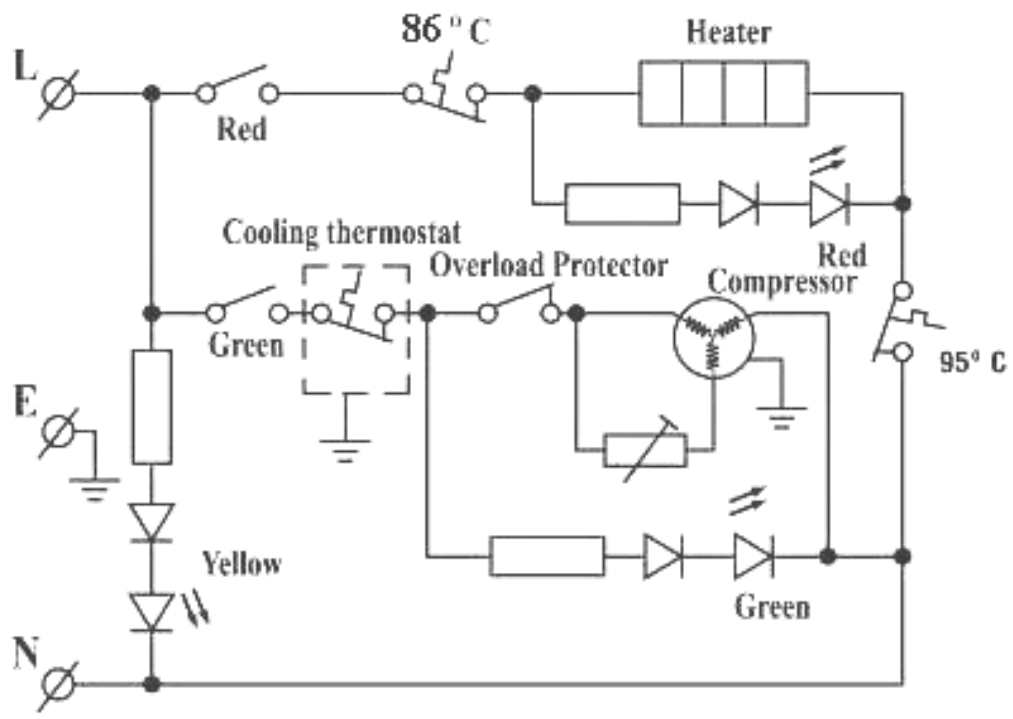

AVISO:
ESTE GRIFO DE AGUA CALIENTE TIENE UN ADAPTADOR DE SEGURIDAD PARA NIÑOS.

PARA OBTENER AGUA CALIENTE:

- ? MUEVA EL BOTON DE SEGURIDAD (COLOR ROJO) HACIA ARRIBA.
- ? MANTENGA AGARRADO ESE BOTON ROJO MIENTRAS QUE APRIETA EL GRIFO.
- ? CUANDO SUELTE EL GRIFO ASEGURESE DE RETORNARLO A LA POSICION ORIGINAL.

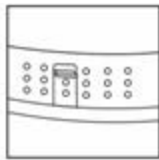

PASOS RECOMENDADOS PARA CAMBIAR EL BOTELLON

- ✍ QUITA EL BOTELLON VACIO.
- ✍ LIMPIA EL CUELLO DEL BOTELLON NUEVO CON UN PAÑO LIMPIO.
- ✍ LEVANTE EL BOTELLON HACIENDO FUERZA CON LAS PIERNAS Y NO LA ESPALDA.
- ✍ TOMA EL BOTELLON POR LOS LADOS Y DIRIJA EL CUELLO DEL MISMO HACIA LA APERTURA DEL TANQUE.
- ✍ VOLTEE EL BOTELLON COMO SI FUERA A SOLTAR AGUA E INSERTE EL CUELLO DEL BOTELLON EN LA APERTURA DEL TANQUE HASTA QUE SE COLOQUE EN LA POSICION CORRECTA.

IMPORTANTE

CUANDO REEMPLACE EL BOTELLÓN, ABRA EL GRIFO DE AGUA CALIENTE Y ELIMINE NO MENOS DE 4 VASOS LLENOS DE AGUA PARA ASEGURAR EL PASO DEL AGUA A TRAVES DE LA UNIDAD Y QUE EL NIVEL DEL AGUA LLEGUE AL NIVEL APROPIADO.

DIRECCIONES BASICAS DE OPERACION:

- ✍ COLOQUE EL ENFRIADOR DE PIE POR UN PERIODO DE DOS HORAS ANTES DE ENCHUFAR LA UNIDAD A LA PARED.
- ✍ COLOQUE EL ENFRIADOR EN UN AREA BIEN VENTILADA Y DEJE UN ESPACIO DE UN POCO MAS DE DOS PULGADAS ENTRE LA UNIDAD Y LA PARED.
- ✍ ESCOJA UN LUGAR CON PISO NIVELADO.
- ✍ NO COLOQUE EL ENFRIADOR DONDE LA TEMPERATURA AMBIENTAL PUEDA BAJAR DE 32°F (0°C).

ANTES DE ENCHUFARLO

AUNQUE EL ENFRIADOR SALE LIMPIO DE LA FABRICA, DEBE LIMPIAR Y ESTERILIZAR LOS CONDUCTOS DEL TANQUE Y LOS GRIFOS DE ACUERDO A LOS SIGUIENTES PASOS:

- ✍ LLENE EL TANQUE DE AGUA (HASTA EL TOPE) CON AGUA DE LA LLAVE.
- ✍ DEJE NIVELAR EL AGUA POR 5 MINUTOS.
- ✍ APRIETE EL BOTON (GRIFO) DE AGUA CALIENTE HASTA QUE SALGA AGUA Y CIERRELA INMEDIATAMENTE.
- ✍ ENCHUFE LA UNIDAD A LA PARED. LOS DOS INDICADORES DE LUZ SE ALUMBRARAN. ESPERE HASTA QUE EL INDICADOR DE AGUA CALIENTE SE APAGUE (APROX. 10 MINUTOS).

- ✍ ENTONCES ESPERE HASTA QUE EL INDICADOR DE AGUA FRIA SE APAGUE (APROX. 5 MINUTOS).
- ✍ DESCONECTE LA UNIDAD DE LA PARED.
- ✍ EMPIECE A DRENAR LOS GRIFOS UNA A LA VEZ HASTA QUE SALGA EL ULTIMO CHORRO DE AGUA.
- ✍ EN LA PARTE TRASERA DE LA UNIDAD ENCONTRARA UNA TAPA PLASTICA. GIRE LA TAPA HACIA LA IZQUIERDA HASTA QUE SALGA EL ULTIMO CHORRO.
- ✍ CUANDO NO SALGA MAS AGUA DE LA APERTURA, CIERRE LA TAPA PLASTICA.
- ✍ TOME EL BOTELLON DE AGUA Y SIGA LAS INSTRUCCIONES PARA CAMBIAR EL BOTELLON.

- ✍ ENCHUFE LA UNIDAD. AHORA SU ENFRIADOR ESTA LISTO PARA SU USO.

CONTROLES DE OPERACION

- ✍ CONTROL DE AGUA FRIA:
 ENCIENDA EL INTERRUPTOR DE AGUA FRIA (13). EL INDICADOR DE LUZ VERDE (4) SE ENCENDERA Y EL PROCESO DE ENFRIAMIENTO COMENZARA. CUANDO LA TEMPERATURA ALCANCE APROXIMADAMENTE 5-7°C LA LUZ VERDE SE APAGARA AUTOMATICAMENTE.

- ✍ CONTROL DE AGUA CALIENTE:
 ENCIENDA EL INTERRUPTOR DE AGUA CALIENTE (12). EL INDICADOR DE LUZ ROJA (2) SE ENCENDERA Y EL PROCESO DE CALENTAMIENTO DEL AGUA COMENZARA. CUANDO LA TEMPERATURA ALCANCE APROXIMADAMENTE 80°C LA LUZ ROJA SE APAGARA AUTOMATICAMENTE Y OTRO CICLO DE CALENTAMIENTO EMPEZARA.

MANTENIMIENTO

- ✍ A INTERVALOS REGULARES (UNA VEZ AL MES), INSPECCIONE EL CONDENSADOR O REJILLA DE ALAMBRE LOCALIZADA EN LA PARTE TRASERA DE LA UNIDAD.
- ✍ ANTES DE EFECTUAR LA LIMPIEZA, DESENCHUFE EL ENFRIADOR. USE UNA ASPIRADORA O UN CEPILLO DURO PARA QUITAR EL POLVO.
- ✍ PARA LIMPIAR LAS PARTES DE PLASTICO SE REQUIERE JABON LIQUIDO Y AGUA TIBIA. NO USE LIMPIADORES ABRASIVOS EN LA SUPERFICIE SUPERIOR NI EN LA BANDEJA DE ESCURRIMIENTO.

SI NO VA A USAR EL ENFRIADOR POR UN TIEMPO PROLONGADO

- ✍ DESENCHUFE LA UNIDAD.
- ✍ QUITE EL BOTELLON DE AGUA.
- ✍ COLOQUE EL INTERRUPTOR MARCADO CALIENTE (EN LA PARTE TRASERA) EN LA POSICION "OFF".
- ✍ DRENE EL AGUA ABRIENDO LAS LLAVES.
- ✍ DRENE LA APERTURA EN LA PARTE TRASERA QUITANDO EL TAPON.
- ✍ EL ENFRIADOR DEBE TRANSPORTARSE PARADO Y CUBIERTO CON UNA FRAZADA PARA EVITAR QUE SE RAYE.

INSTRUCCIONES PARA ASEGURAR SU UNIDAD AVANTI A LA PARED

1- DETRAS DE LA UNIDAD HAY UNAS PERFORACIONES PARA LA INSTALACION DE SOPORTES LATERALES, USANDO TORNILLOS (VEA FIGURA 1).

2- DESPUES DE INSTALAR AMBOS SOPORTES, USE EL EXTREMO DEL SOPORTE PARA OBTENER LAS SIGUIENTES MEDIDAS:
MIDA LA DISTANCIA ENTRE EL PISO Y EL CENTRO DEL HUECO DEL SOPORTE YA PREVIAMENTE INSTALADO (VEA FIGURA 2A).
MIDA LA DISTANCIA QUE EXISTE ENTRE EL CENTRO DE LOS HUECOS DE LOS DOS SOPORTES (VEA FIGURA 2B).
AMBAS MEDIDAS LE DARAN EXACTAMENTE LA LOCALIZACION PARA BARRENAR Y ASEGURAR SU UNIDAD A LA PARED ESCOGIDA.

3- IMPORTANTE TENER PRESENTE QUE DIFERENTES TIPOS DE TORNILLOS PUEDEN SER USADOS, DEPENDIENDO DE LA CONSTRUCCIÓN DE LA PARED (ESTOS TORNILLOS Y ANCLAS NO VIENEN INCLUIDOS).

FIGURA 1

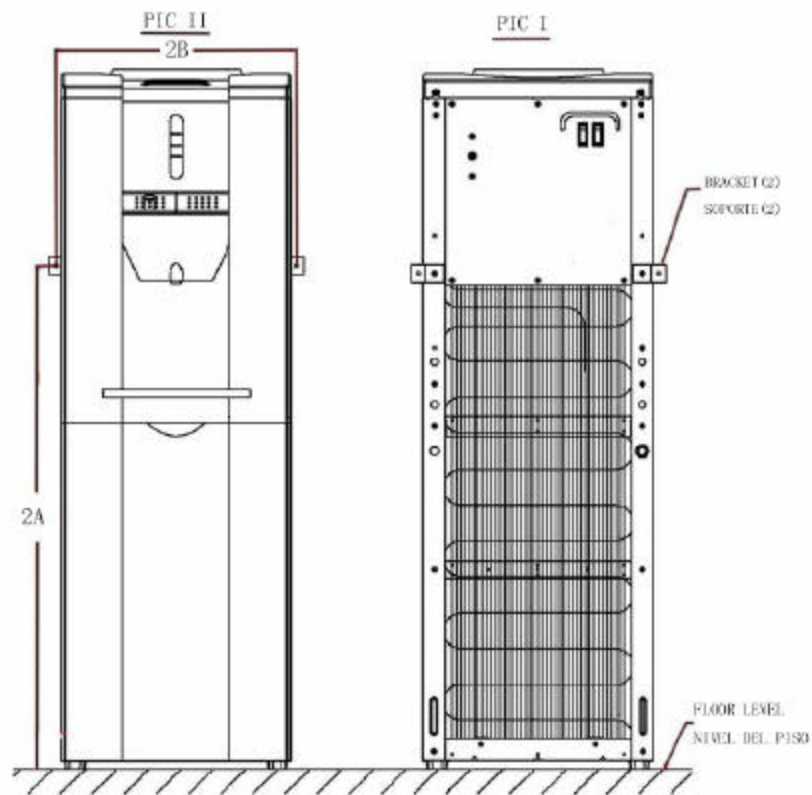

POSIBLES PROBLEMAS

CAUSA

DERRAME DE AGUA POR FUERA DEL ENFRIADOR	LA BOTELLA ESTA PERFORADA - REEMPLACELA
EL AGUA NO ESTA SUFICIENTEMENTE FRIA.	SU TEMPERATURA DEBERIA SER DE 5? A 7? C CON UNA TEMPERATURA AMBIENTE DE 20? C. SI NO ES ASI, LLAME AL CENTRO DE SERVICIO, EL TERMOSTATO PODRIA ESTAR DEFECTUOSO.
EL AGUA NO ESTA SUFICIENTE CALIENTE	SU TEMPERATURA DEBERIA SER DE 80? A 90? C CON UNA TEMPERATURA AMBIENTE DE 20? C. SI NO ES ASI, LLAME AL CENTRO DE SERVICIO, EL TERMOSTATO PODRIA ESTAR DEFECTUOSO.
EL ENFRIADOR NO ENFRIA O CALIENTA EL AGUA	VERIFIQUE LOS CIRCUITOS, FUSIBLES O DISYUNTORES.

PARTES Y CARACTERISTICAS

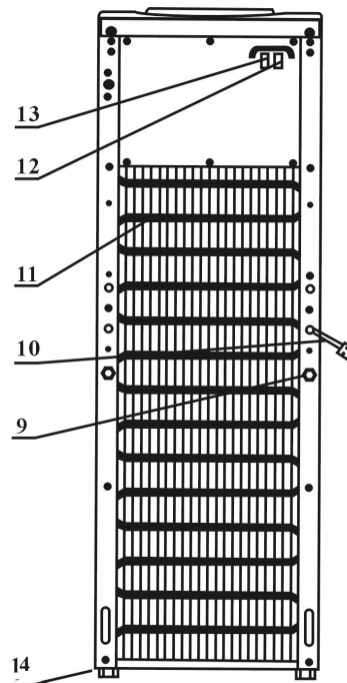
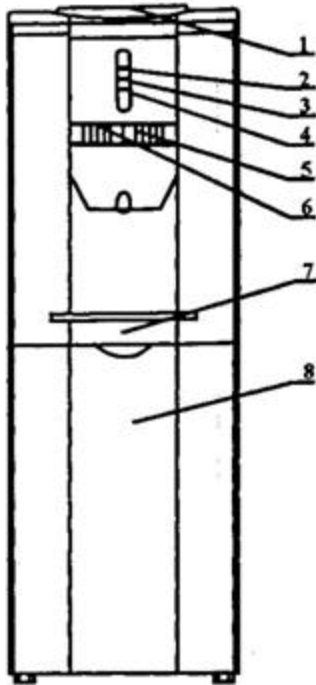

1. TOMA DE AGUA
2. INDICADOR DE CALOR (ROJO)
3. INDICADOR DE ENERGIA (AMARILLO)
4. INDICADOR DE ENFRIAMIENTO (VERDE)
5. LLAVE DE AGUA FRIA (AZUL)
6. LLAVE DE AGUA CALIENTE / SEGURO PARA NIÑOS (ROJO)
7. CHAROLA REMOVIBLE

8. COMPARTIMIENTO
9. DRENAJE DE AGUA CALIENTE
10. ENCHUFE DE CORRIENTE
11. SERPENTIN DEL CONDENSADOR
12. INTERRUPTOR DE CALOR (ROJO)
13. INTERRUPTOR DE ENFRIAMIENTO (VERDE)
14. PATAS